



2019

STANDARD PROFILE CATALOGUE

TUBING
 Square..... 2
 Rectangular..... 3
 Round..... 4-5

ANGLES
 Equal Leg..... 6
 Unequal Leg..... 7

CHANNELS
 Equal Leg 8-9
 Lipped & Top Hat 10

MISC
 T & H Sections..... 11

BAR
 Flat Bar 12
 Hexagon Bar 13
 Square Bar..... 13
 Round Bar..... 13



WISPECO EXTRUSION DESIGN

The extruded sections shown in this catalogue are in general demand and available to any customer. Thousands of other profiles have been designed for customers and specifiers to suit specific purposes.

Wispeco will be pleased to assist you with the design of aluminium extrusions to suit your specific requirements.

FINISHING OF ALUMINIUM EXTRUSIONS

Wispeco Aluminium is able to offer a variety of finishes for aluminium extrusions which includes anodising and powder coating.

ENQUIRIES

Johannesburg (011) 389-0000
Durban (031) 579-8337
Cape Town (021) 959-5400

ALUMINIUM ALLOYS

DESIGNATION	Description	Finishing	Available Forms				Typical Uses
			Anodising Response	Shapes	Tubing	Bars	
1350	Electrically pure aluminium with conductivity of 60% of I.A.C.S.	-	All	✓	FLAT		Busbar. All electrical conductor requirements.
6063	Sustainable for intricate sections of medium strength. Forms well in "F" and "T1" conditions. High Corrosion resistance. Good surface finish.	Very Good	All	✓		✓	Architectural members such as window frames and shop-fitting shapes. Irrigation tubes. General Purpose Use.
6463	A modified 6063. Responds well to chemical brightening.	Very Good	All	✓		✓	Bright trim. Extruded reflector shapes.
6101	The best combination of electrical and mechanical conductor properties. Conductivity 55% of I.A.C.S.	-	Structural	✓	✓	✓	Busbar. Electrical conductors and fittings.
6261	General purpose structural alloy. Good mechanical properties. Good corrosion resistance and weldability.	Good	Structural	✓	✓	✓	Structural applications of all kinds. Road and rail transport. Mine cages, cranes, bridges, towers, roof trusses, etc.
6082	General purpose structural alloy. Good mechanical properties. Good corrosion resistance and weldability.	Good	Structural	✓	✓	✓	Bolts, nuts, drive screws, etc.
6005	Medium strength alloy.	Fair	Limited	✓	✓	✓	Ladders, Design applications requiring characteristics between 6063 and 6082.

This manual has been compiled to assist both the stockist and the manufacturer.

Every effort has been made to ensure accuracy of data, but no responsibility can be accepted for errors or omissions due to our continuous policy of research and development.

Wispeco Aluminium reserves the right to alter or amend dimensions and/or specifications without prior notice.

TEMPER DESIGNATIONS

DESIGNATION	Approximate Equivalent	Description
F	M M	As fabricated. Applies to the product of shaping process in which no special control over thermal conditions or strain-hardening is employed
T1	TB W	Cooled from an elevated temperature shaping process and naturally aged to substantially stable condition
T5	TE P	Cooled from an elevated temperature shaping process and then artificially aged
T6	TF WP	Solution heat-treated and then artificially aged

NOTE: 1350 is a non-heat treatable alloy and is always supplied in the "F" Condition.

CHEMICAL COMPOSITION (NOMINAL)

ALLOY	Si	Fe	Cu	Mn	Mg	Cr	Zn	Ti
6063	0.20 - 0.60	0.35	0.10	0.10	0.45 - 0.90	0.10	0.10	0.10
6351	0.70 - 1.30	0.50	0.10	0.40 - 0.80	0.40 - 0.80	-	0.20	0.20
6463	0.20 - 0.60	0.15	0.20	0.05	0.45 - 0.90	-	0.05	0.05
1350	0.10	0.40	0.05	0.01	-	0.01	0.05	-
6101	0.30 - 0.70	0.50	0.10	0.03	0.35 - 0.80	0.03	0.10	-
6005	0.60 - 0.90	0.35	0.10	0.10	0.40 - 0.60	0.10	0.10	0.10
6261	0.40 - 0.80	0.40	0.15 - 0.40	0.20 - 0.35	0.70 - 1.00	0.10	0.20	0.20

NOTES: 1. Balance Aluminium (Al)
2. Except where range is shown, all values are maxima
3. Material is available to various international standards

TUBING

Square	2
Rectangular	3
Round	4-5

ANGLES

Equal Leg	6
Unequal Leg	7

CHANNELS

Equal Leg	8-9
Lipped & Top Hat	10

MISC

T & H Sections	11
----------------	----

BARS

Flat Bar	12
Hexagon Bar	13
Square Bar	13
Round Bar	13

COPYRIGHT

DESIGNS, DRAWINGS AND SPECIFICATIONS AND THE COPYRIGHT THEREIN ARE THE PROPERTY OF WISPECO PTY LTD. ALL THE DIES ARE REGISTERED AND RESERVED.



HOLLOW

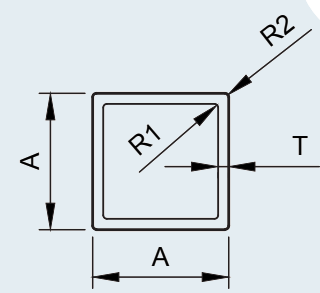

SECTION NO.	RANGE	A	T	R1	R2	Kg/m	PAINT PERIMETER	ANODIZED PERIMETER	
42357	> 10mm	11.80	1.20	0.30	0.30	0.138	100	100	
50055		12.00	1.20	0.30	0.30	0.140	100	100	
55783		12.70	1.50	0.30	0.30	0.182	100	100	
42326		15.00	1.20	0.30	0.30	0.179	100	100	
57018		16.00	1.20	0.30	0.30	0.193	100	100	
53664		16.00	1.60	0.30	0.30	0.248	100	100	
42912		18.00	1.20	0.30	0.30	0.219	100	103	
54060		19.00	1.50	0.30	0.30	0.285	100	108	
50060		19.00	1.60	0.30	0.30	0.302	107	107	
50059		19.00	3.20	0.30	0.30	0.548	100	101	
42406	> 20mm	20.00	1.10	0.30	0.30	0.226	100	116	
55884		20.00	1.10	3.90	5.00	0.202	100	104	
52493		20.00	1.30	0.30	1.00	0.261	100	113	
42179		20.00	1.50	0.60	0.60	0.301	100	114	
10871		20.00	1.50	0.30	0.30	0.301	100	114	
00193		20.00	1.60	0.30	0.30	0.319	100	113	
56060		20.00	2.00	0.30	0.30	0.391	100	111	
50064		21.00	1.20	0.30	0.30	0.257	100	120	
42435		21.00	1.30	0.40	0.40	0.277	100	139	
00012		22.20	2.00	1.20	3.20	0.418	100	119	
50382		22.50	2.00	0.75	2.50	0.432	100	122	
50065		24.00	1.20	0.30	0.30	0.296	100	138	
42390		24.00	1.30	0.30	0.30	0.319	100	139	
50347		25.00	1.30	2.00	1.30	0.343	100	143	
56616		25.00	1.40	0.30	0.30	0.358	100	143	
50066		25.00	1.50	0.30	0.30	0.382	100	143	
42178		25.00	1.50	0.30	0.80	0.381	100	142	
54927		25.00	1.60	0.30	0.30	0.405	100	143	
55408		25.00	2.00	0.90	0.90	0.500	100	139	
53916		25.00	2.00	4.00	6.00	0.452	100	129	
50609		25.00	3.00	0.30	0.30	0.716	100	137	
10628		25.40	2.00	0.30	0.30	0.507	102	145	
00022		25.40	3.18	0.70	3.96	0.731	100	133	
55162		25.90	1.90	0.30	0.30	0.494	103	147	
56693		27.20	1.50	1.00	0.30	0.416	105	155	
11433		> 30mm	30.00	1.60	0.30	0.30	0.492	120	144
42886			30.00	2.00	0.30	0.50	0.608	120	172
56692			31.00	1.60	0.30	0.30	0.510	124	180
00101			31.80	3.20	0.63	0.63	0.993	126	176
55144			33.60	1.50	0.30	0.30	0.522	134	195
10223	38.00		1.70	1.00	0.30	0.667	152	221	
00041	38.00		2.00	0.30	1.27	0.777	150	218	
42274	38.00		3.00	1.00	2.00	1.132	149	212	
50070	38.00	3.00	0.30	0.30	1.139	151	215		
55899	> 40mm	40.00	2.00	0.30	0.30	0.825	160	232	
56965		40.00	2.50	0.30	0.30	1.017	160	230	
56207		40.00	3.00	0.30	0.30	1.204	160	228	
42938		44.00	3.00	2.00	0.50	1.343	175	250	
58335	50mm	50.00	1.50	0.30	0.30	0.789	200	294	
56655		50.00	2.00	0.50	2.50	1.028	196	287	
11173		50.00	3.00	0.30	0.30	1.529	200	288	
56066		50.00	6.00	0.30	0.30	2.864	200	275	
00256		50.80	3.20	1.60	1.60	1.653	200	288	
56924	> 60mm	60.00	2.00	0.30	0.30	1.258	240	352	
56081		60.00	3.00	0.30	0.30	1.855	239	347	
42145		63.50	6.40	1.60	6.36	3.877	243	343	
56121	> 70mm	70.50	2.50	0.30	0.30	1.830	278	409	
11517		76.00	2.00	0.30	0.30	1.605	304	448	
50075		76.20	1.70	0.30	0.30	1.374	304	450	
42371		77.80	2.00	0.30	0.30	1.644	311	458	
55210	> 100mm	100.00	2.00	0.30	0.30	2.126	399	591	
13029		100.00	3.50	0.30	0.30	3.644	400	586	
55906		100.00	6.00	0.30	0.30	6.119	399	575	
55126		114.50	2.00	0.40	0.40	2.441	457	678	

Material Specifications

All material will be Aluminium 6063-T6 unless specified or requested. All lengths can be supplied in 6m lengths. Longer lengths can be supplied on special request.

Surface Finish

All lengths are available in mill finish, powder coated or anodised.

TUBING

- Square 2
- Rectangular 3
- Round 4-5

ANGLES

- Equal Leg 6
- Unequal Leg 7

CHANNELS

- Equal Leg 8-9
- Lipped & Top Hat 10

MISC

- T & H Sections 11

BARS

- Flat Bar 12
- Hexagon Bar 13
- Square Bar 13
- Round Bar 13



HOLLOW

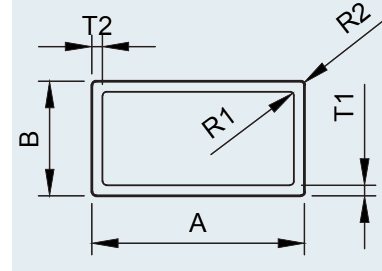

SECTION NO.	RANGE	A	B	T1	T2	R1	R2	Kg/m	PAINT PERIMETER	ANODIZED PERIMETER
58171	> 10mm	15.00	10.00	1.50	1.50	0.30	0.30	0.179	100	100
11922		18.00	12.00	1.20	1.20	0.30	0.30	0.179	100	100
55237		18.00	12.00	1.50	1.50	1.00	0.30	0.220	100	100
42593	> 20mm	20.00	10.00	1.20	1.20	0.30	0.30	0.179	100	100
55351		24.00	18.00	1.20	1.20	0.30	0.30	0.258	100	120
53661		24.00	18.00	1.20	1.20	2.30	3.50	0.240	100	114
11499		25.00	12.00	1.50	1.50	0.30	0.30	0.277	100	104
54935		25.00	15.00	1.30	1.30	0.30	0.30	0.263	100	114
54237		25.00	20.00	2.00	2.00	2.00	0.30	0.435	100	123
54632	28.50	12.50	1.70	1.70	0.80	1.40	0.341	100	113	
42297	> 30mm	30.00	20.00	1.20	1.20	3.80	5.00	0.285	100	133
11254		30.00	20.00	1.20	1.20	1.30	2.50	0.299	100	140
52102		33.00	20.00	1.20	1.40	1.60	3.00	0.333	101	148
42104		33.00	20.00	1.30	1.30	2.25	3.50	0.338	100	146
54213		35.00	25.00	2.00	2.00	0.30	0.30	0.607	120	171
42701		35.00	25.40	1.60	1.60	0.80	2.40	0.485	117	171
57374		35.00	25.50	1.40	1.40	0.50	2.00	0.429	118	172
00269		35.30	25.50	1.60	1.60	0.30	0.30	0.499	121	175
50900		36.00	20.00	3.00	3.00	0.30	0.30	0.817	111	155
42484		38.00	20.00	1.30	1.30	0.50	1.00	0.388	115	168
55097		38.00	25.00	1.50	1.50	0.30	0.30	0.488	125	182
55007		38.00	25.00	2.00	2.00	0.30	0.30	0.640	125	180
53801		38.00	25.00	2.40	2.40	0.30	0.30	0.757	125	178
56621	> 40mm	40.00	20.00	2.00	2.00	0.30	0.30	0.608	119	171
10939		40.00	29.50	1.50	1.50	0.30	0.30	0.549	120	174
55559		40.00	30.00	2.50	2.50	0.30	0.30	0.881	139	199
42197		43.00	16.00	1.90	1.90	0.30	0.30	0.569	118	170
52099		45.00	20.00	1.40	1.40	1.50	3.00	0.456	125	184
53295	48.00	22.00	1.20	1.50	0.50	2.00	0.463	136	200	
56805	> 50mm	50.00	12.00	2.00	2.00	0.30	0.30	0.629	123	177
58398		50.00	20.00	2.00	2.00	0.30	0.30	0.716	139	201
50101		50.00	25.00	1.50	1.50	0.30	0.30	0.585	149	218
53111		50.00	25.00	2.00	2.00	0.30	0.30	0.770	150	217
53917		50.00	25.00	2.00	2.00	4.00	6.00	0.723	140	204
11175		50.00	25.00	2.50	2.50	0.30	0.30	0.949	149	214
42645		50.00	25.00	3.00	3.00	3.50	6.00	1.053	139	199
57620		50.00	25.00	3.20	3.20	0.30	0.30	1.190	212	150
10940		50.00	29.50	1.50	1.50	0.30	0.30	0.622	159	233
54306		50.00	30.00	2.00	2.00	0.30	0.30	0.824	159	231
13117		51.00	20.50	1.50	1.50	1.50	3.00	0.542	138	202
42070		51.00	25.50	2.50	2.50	0.70	0.70	0.968	151	219
56347		51.00	25.50	4.00	4.00	0.30	2.00	1.477	149	209
42619	57.00	20.80	2.00	2.00	0.80	0.80	0.801	154	223	
53384	> 60mm	60.00	40.00	3.00	3.00	0.30	0.75	1.529	199	287
13038		60.50	30.50	1.80	1.80	0.50	1.20	0.850	180	264
00247		63.50	31.80	2.30	2.30	0.30	0.30	1.131	191	268
10941		67.50	29.50	1.70	1.70	0.30	0.30	0.861	194	284
11493	> 70mm	76.00	38.00	2.00	2.00	0.30	0.30	1.193	228	334
54156		76.00	60.00	2.00	2.00	0.30	0.30	1.432	271	399
42628		76.20	38.00	3.20	3.20	0.75	0.75	1.870	227	329
56300		76.00	51.00	4.00	4.00	2.00	4.00	2.554	247	356
10942	> 80mm	80.50	29.50	1.80	1.80	0.30	0.30	1.038	221	325
42608		82.50	31.50	1.70	2.60	6.00	7.50	1.110	215	315
56257		82.50	31.80	1.90	3.00	4.75	6.35	1.264	218	319
10807		89.00	22.00	2.50	2.50	0.30	0.30	1.436	222	323
42194	98.00	18.00	2.00	2.00	0.30	0.30	1.215	231	339	
11321	> 100mm	100.00	29.50	2.00	2.00	0.30	0.30	1.361	259	381
42534		100.00	38.00	2.00	2.00	1.50	0.30	1.458	276	405
54126		100.00	50.00	2.00	2.00	0.30	0.30	1.583	299	440
55842		100.00	50.00	3.00	3.00	0.30	0.30	2.343	299	437
00414		101.00	50.00	4.50	4.50	0.63	1.78	3.461	299	431
00803		101.50	44.50	3.20	3.20	0.30	0.38	2.428	292	426
42505		101.50	45.00	1.80	1.80	0.30	1.50	1.390	291	431
56350		101.50	51.00	3.25	3.25	0.30	2.00	2.565	301	441
55163	101.50	76.00	2.00	2.00	0.30	2.00	1.873	352	522	
42829	> 110mm	110.00	40.00	3.00	3.00	0.30	0.30	2.435	300	437
42722		120.00	80.00	4.00	4.00	3.00	4.00	4.149	393	575
57942		130.00	70.00	2.00	2.00	0.30	0.30	2.126	399	591
55951		140.00	44.00	3.00	3.00	0.30	0.30	2.897	367	539
42409		146.00	32.00	3.00	3.00	0.30	0.30	2.800	355	521
42533		150.00	38.00	2.00	2.00	1.50	0.30	2.001	376	554
58101		150.00	50.00	1.80	1.80	0.30	0.30	1.918	400	592
55209		150.00	50.00	2.00	2.00	0.30	0.30	2.126	399	591
55124		150.00	50.00	3.00	3.00	0.40	0.40	3.157	399	587
42317		163.00	50.00	3.00	3.00	0.30	0.30	3.368	425	626

TUBING

- Square 2
- Rectangular 3
- Round 4-5

ANGLES

- Equal Leg 6
- Unequal Leg 7

CHANNELS

- Equal Leg 8-9
- Lipped & Top Hat 10

MISC

- T & H Sections 11

BARS

- Flat Bar 12
- Hexagon Bar 13
- Square Bar 13
- Round Bar 13

Material Specifications

All material will be Aluminium 6063-T6 unless specified or requested. All lengths can be supplied in 6m lengths. Longer lengths can be supplied on special request.

Surface Finish

All lengths are available in mill finish, powder coated or anodised.

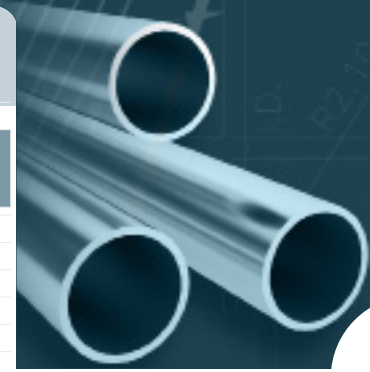

HOLLOW

SECTION NO.	RANGE	OD	T	ID	Kg/m	PAINT PERIMETER	ANODIZED PERIMETER	SECTION NO.	RANGE	OD	T	ID	Kg/m	PAINT PERIMETER	ANODIZED PERIMETER	
50128	< 10mm	8.00	1.20	5.60	0.069	100	100	11328	> 20mm	23.80	4.00	15.80	0.675	100	100	
55146		9.00	1.20	6.56	0.080	100	100	53890		24.70	1.40	21.90	0.277	100	112	
50130		9.50	1.20	7.10	0.084	100	100	53885		25.00	2.00	21.00	0.392	100	112	
50131		9.70	1.30	7.10	0.093	100	100	55768		25.00	1.80	21.40	0.356	100	113	
55721		9.80	1.20	7.40	0.087	100	100	50154		25.00	1.60	21.80	0.319	100	113	
								50153		25.00	1.40	22.20	0.281	100	114	
50132	> 10mm	10.00	1.20	7.60	0.090	100	100	50115		25.00	1.20	22.60	0.245	100	114	
50133		10.00	1.50	7.00	0.109	100	100	54368		25.00	1.15	22.70	0.233	100	114	
42865		10.00	1.60	6.80	0.114	100	100	50541		25.00	3.00	19.00	0.562	100	109	
55317		10.00	2.80	4.30	0.173	100	100	52782		25.50	1.20	23.10	0.248	100	117	
50134		12.00	2.60	6.80	0.208	100	100	42684		25.50	1.25	23.00	0.258	100	116	
11552		12.20	1.20	9.80	0.112	100	100	54265		25.50	1.50	22.50	0.306	100	115	
50135		12.70	1.20	10.30	0.117	100	100	42685		25.50	1.60	22.30	0.326	100	115	
42676		12.70	1.65	9.40	0.155	100	100	42725		25.50	2.00	21.50	0.400	100	114	
53925		12.70	2.00	8.70	0.182	100	100	42714		25.50	3.20	19.10	0.602	100	110	
42737		12.70	2.65	7.40	0.225	100	100	50251		25.50	5.00	15.50	0.873	100	104	
42823		12.70	3.20	6.30	0.259	100	100	53614		25.50	5.20	15.10	0.899	100	104	
57432		13.70	3.10	7.50	0.279	100	100	42356		26.30	1.20	23.90	0.257	100	121	
55548		14.00	3.60	6.80	0.319	100	100	54887	26.30	5.60	15.10	0.988	100	107		
53001		14.30	2.50	9.30	0.251	100	100	55098	26.80	2.00	22.80	0.423	100	120		
50628		15.00	1.50	12.00	0.172	100	100	42578	27.30	3.00	21.30	0.621	100	120		
10631		15.80	1.20	13.40	0.149	100	100	55905	27.80	1.40	25.00	0.315	100	126		
50142		15.80	2.00	11.80	0.236	100	100	56510	28.00	1.50	25.00	0.339	100	127		
42724		15.90	1.60	12.70	0.195	100	100	50160	28.50	1.60	25.30	0.367	100	129		
53676		16.00	1.20	13.60	0.150	100	100	56255	28.60	1.20	26.20	0.280	100	131		
42511		16.00	1.50	13.00	0.185	100	100	42726	28.60	1.60	25.40	0.360	100	130		
56118		16.00	4.00	8.00	0.408	100	100	55649	29.00	1.20	26.60	0.284	100	133		
11325		16.50	2.80	10.90	0.327	100	100	54066	29.20	1.20	27.10	0.286	100	133		
13190		16.50	3.70	9.10	0.401	100	100	52566	29.60	4.80	20.00	1.014	100	123		
56295		18.50	4.30	9.90	0.520	100	100									
42678		19.00	1.20	16.60	0.182	100	100	42499	30.00	1.20	27.60	0.294	100	138		
55802		19.00	1.50	16.00	0.223	100	100	53734	30.00	2.00	26.00	0.475	100	135		
50540		19.00	1.60	15.80	0.237	100	100	13193	30.00	5.30	19.40	1.118	100	125		
53659		19.00	2.00	15.00	0.289	100	100	58344	30.00	6.25	17.50	1.265	122	100		
11326		19.00	3.20	12.60	0.430	100	100	52207	31.20	2.80	25.60	0.677	100	138		
42739		19.30	3.20	12.90	0.439	100	100	42686	31.80	1.60	28.60	0.412	100	145		
									42687	31.80	3.20	25.40	0.780	100	140	
56669		> 20mm	20.00	4.50	11.00	0.549	100	100	58364	32.00	3.00	26.00	0.741	142	101	
53613			20.00	4.80	10.40	0.621	100	100	42498	33.00	1.20	30.60	0.325	104	152	
50254			20.00	6.25	7.50	0.732	100	100	50949	33.00	5.00	23.00	1.192	104	140	
11327			21.30	3.60	14.10	0.542	100	100	53112	33.00	5.50	22.00	1.289	104	138	
50146			21.40	1.40	18.60	0.238	100	100	42345	33.00	6.30	20.50	1.450	104	136	
13097			21.70	2.20	17.30	0.366	100	100	13338	34.50	7.60	19.30	1.742	108	139	
42355			21.80	1.40	19.00	0.243	100	100	55145	35.00	1.70	31.60	0.482	110	160	
50114	22.00		1.20	19.60	0.213	100	100	57089	35.00	2.00	31.00	0.562	110	159		
50148	22.00		1.40	19.20	0.246	100	100	54940	35.00	2.50	30.00	0.692	110	157		
11683	22.20		1.60	19.00	0.281	100	100	50162	35.00	4.70	25.60	1.213	110	150		
42681	22.25		1.20	19.85	0.215	100	100	50613	37.50	1.20	35.10	0.371	118	173		
53649	22.25		2.80	16.65	0.464	100	100	50270	38.00	1.20	35.60	0.376	119	175		
50013	23.00		4.80	13.40	0.744	100	100	10635	38.00	1.60	34.80	0.496	120	174		
									42689	38.00	2.00	34.00	0.602	119	166	
									50619	38.00	3.00	32.00	0.895	119	169	
									42691	38.00	3.20	31.60	0.948	119	169	
									42346	38.00	7.50	23.00	1.949	119	155	
								56245	38.00	8.20	21.60	2.082	120	153		
								54933	40.00	1.50	37.00	0.492	126	184		
								56236	40.00	3.00	34.00	0.945	126	180		
								58116	40.00	5.00	30.00	1.491	126	173		
								57076	40.00	8.50	23.00	2.281	126	162		
								42749	41.30	4.70	31.90	1.466	130	180		
								13340	42.50	7.25	28.00	2.178	134	100		
								42347	43.00	7.30	28.40	2.221	135	179		
								42692	44.50	3.20	38.10	1.126	140	200		
								11444	45.00	2.50	40.00	0.905	134	197		
								13283	46.50	10.80	24.90	3.285	146	185		
								54342	47.00	1.20	44.60	0.468	147	217		
								42302	48.00	8.50	31.00	2.860	151	200		
								54748	48.00	3.00	42.00	1.150	151	217		
								42752	48.50	4.50	39.50	1.687	152	214		

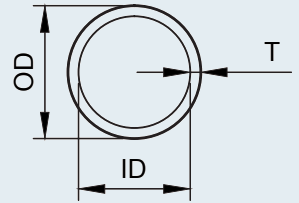

TUBING
Square 2
Rectangular 3
Round 4-5

ANGLES
Equal Leg 6
Unequal Leg 7

CHANNELS
Equal Leg 8-9
Lipped & Top Hat 10

MISC
T & H Sections 11

BARS
Flat Bar 12
Hexagon Bar 13
Square Bar 13
Round Bar 13

Material Specifications

All material will be Aluminium 6063-T6 unless specified or requested. All lengths can be supplied in 6m lengths. Longer lengths can be supplied on special request.

Surface Finish

All lengths are available in mill finish, powder coated or anodised.

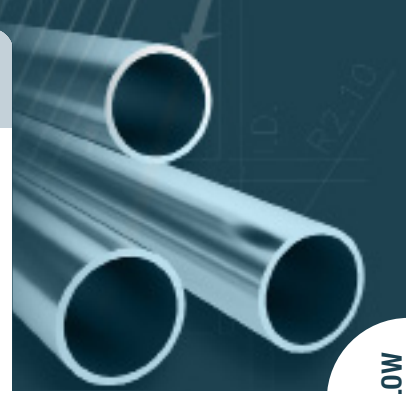

HOLLOW

SECTION NO.	RANGE	OD	T	ID	Kg/m	PAINT PERMETER	ANODIZED PERMETER
11167	> 50mm	50.00	1.50	47.00	0.619	157	231
50749		50.00	1.80	46.40	0.739	157	230
42330		50.00	1.90	46.20	0.779	157	230
54932		50.00	2.00	46.00	0.818	157	229
42331		50.00	2.20	45.60	0.896	157	229
53887		50.00	5.00	40.00	1.917	157	220
42965		50.60	1.50	47.60	0.627	159	234
54948		50.60	1.90	46.80	0.788	159	232
50173		50.80	3.00	44.80	1.201	160	231
50174		50.80	5.00	40.80	1.951	160	224
50170		51.00	1.20	48.60	0.509	160	237
42693		51.00	1.30	48.40	0.551	160	236
50172		51.00	1.60	47.80	0.673	160	235
50120		51.00	1.90	47.20	0.795	160	234
42694		51.00	2.00	47.00	0.835	160	234
10629		51.00	3.20	44.60	1.303	160	230
11443		55.00	2.50	50.00	1.118	165	244
13339		58.00	8.50	41.00	3.585	182	246
54870		58.00	12.00	34.00	4.703	182	236
56307		59.00	9.50	40.00	4.006	185	248
42316	59.00	10.50	38.00	4.339	185	245	
54600	> 60mm	60.00	1.60	56.80	0.796	188	272
42514		60.30	3.20	53.90	1.557	189	274
56280		60.30	4.00	52.30	1.919	189	272
42594		63.50	2.00	59.50	1.048	199	293
42697		63.50	3.20	57.10	1.644	199	289
56308	66.00	11.00	44.00	5.155	207	276	
42647	> 70mm	70.00	1.30	67.40	0.761	220	326
57088		70.00	5.00	60.00	2.770	220	314
56281		72.00	5.20	61.60	2.960	226	323
42327		72.00	6.00	60.00	3.374	226	320
57111		73.00	5.20	60.60	3.004	229	328
42698		76.20	1.30	73.60	0.830	239	354
42855		76.20	1.60	73.00	1.017	240	355
56077		76.20	2.00	72.20	1.125	239	353
42699		76.20	3.20	69.80	1.990	239	349
58104		76.20	6.35	63.50	3.779	239	339
42336	76.30	3.00	70.30	1.874	240	351	
57401	76.50	1.25	74.00	0.801	240	356	
56282	79.40	3.40	72.60	2.202	249	363	
56321	> 80mm	80.00	2.00	76.00	1.329	251	371
52210		80.00	4.00	72.00	2.590	252	366
56106		80.00	5.00	70.00	3.195	252	361
52265		80.00	6.00	68.00	3.783	252	389
11936		80.00	8.00	64.00	4.908	252	303
56306		85.00	19.50	46.00	10.883	267	340
11441		87.00	3.50	80.00	2.478	274	400
56283		87.60	3.50	80.60	2.508	275	402
56739		89.00	3.20	82.60	2.340	280	410
54896		89.00	4.80	79.40	3.443	280	405
11969	> 100mm	100.00	4.00	92.00	3.272	315	466
52353		100.00	6.00	88.00	4.805	314	452
53497		100.00	8.00	84.00	6.243	314	446
56995		100.00	10.00	80.00	7.668	314	439
42731		100.50	4.80	90.90	3.914	316	459
42756		101.00	3.20	94.60	2.666	317	466
11808		101.50	3.20	95.10	2.680	299	468
42854		101.60	1.60	98.40	1.363	319	474
56464		101.60	3.60	94.40	3.006	319	468
42795		104.50	3.30	97.90	2.845	328	482
11440	108.00	4.00	100.00	3.528	340	498	
56237	> 110mm	114.00	4.00	106.00	3.749	358	525
56051		114.00	5.00	104.00	4.643	358	522
11590		114.30	6.00	102.30	5.537	360	520
54050		117.00	2.00	113.00	1.960	368	546
11970	> 120mm	120.00	4.00	112.00	3.953	377	553
11968		120.00	6.00	108.00	5.828	377	547
53495		120.00	8.00	104.00	7.600	377	540
42715		127.00	3.50	120.00	3.684	400	589
56244		140.00	5.00	130.00	5.751	440	644
56067		150.00	6.00	138.00	7.362	471	688
56828		150.00	8.00	134.00	9.679	471	681
56249		157.00	3.00	151.00	3.937	493	730
55908		160.00	6.00	148.00	7.873	503	736
57259		160.00	7.00	146.00	9.126	503	732
58040	160.00	8.00	144.00	10.361	503	729	

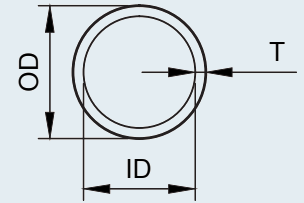

TUBING

- Square 2
- Rectangular 3
- Round 4-5

ANGLES

- Equal Leg 6
- Unequal Leg 7

CHANNELS

- Equal Leg 8-9
- Lipped & Top Hat 10

MISC

- T & H Sections 11

BARS

- Flat Bar 12
- Hexagon Bar 13
- Square Bar 13
- Round Bar 13

Material Specifications

All material will be Aluminium 6063-T6 unless specified or requested. All lengths can be supplied in 6m lengths. Longer lengths can be supplied on special request.

Surface Finish

All lengths are available in mill finish, powder coated or anodised.



SOLIDS

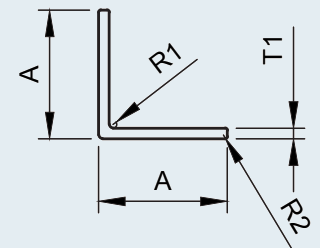

SECTION NO.	RANGE	A	T1	R1	R2	Kg/m	PAINT / ANODIZED PERMETER
11193	> 10mm	12.00	1.50	0.30	0.30	0.092	100
11166		12.00	3.00	0.30	0.30	0.171	100
28241		12.50	1.50	0.30	0.30	0.094	100
02689		12.70	1.60	0.30	0.30	0.103	100
00454		12.70	3.20	0.30	0.30	0.192	100
70143		15.00	1.50	0.30	0.30	0.116	100
27891		15.00	1.60	0.30	0.30	0.122	100
00163		15.90	3.20	0.30	0.30	0.248	100
21081		16.00	1.50	0.30	0.30	0.124	100
10386		19.00	1.60	0.30	0.30	0.157	100
31921		19.00	2.00	0.30	0.30	0.195	100
10588		19.00	3.20	0.30	0.30	0.301	100
11303	> 20mm	22.20	1.60	0.30	0.30	0.185	100
70150		25.00	1.20	0.30	0.30	0.159	100
11356		25.00	1.30	0.30	FULL	0.170	100
34302		25.00	1.50	0.30	0.30	0.197	100
10968		25.00	1.60	0.30	0.30	0.209	100
31922		25.00	2.00	0.30	0.30	0.260	100
70162		25.00	3.00	0.30	0.30	0.382	100
22326		25.50	1.20	0.30	FULL	0.160	100
10387		25.50	1.60	0.30	0.30	0.213	101
18356		25.50	2.50	0.65	0.30	0.328	101
52079		25.50	3.20	0.30	0.30	0.413	101
19010		25.50	4.80	0.30	0.30	0.598	101
00252	25.50	6.40	0.30	0.30	0.770	101	
70298	> 30mm	30.00	3.00	0.30	0.30	0.464	120
28540		31.80	1.60	0.30	0.30	0.268	126
03436		31.80	3.20	0.30	0.30	0.524	126
52081		31.80	4.80	0.30	0.30	0.765	126
52082		31.80	6.40	0.30	0.30	0.992	126
70152		32.00	3.00	0.30	0.30	0.496	127
19322		38.00	1.20	0.30	0.30	0.243	152
30674		38.00	1.60	0.30	0.30	0.323	152
28959		38.00	1.80	0.30	0.30	0.362	151
10967		38.00	2.00	0.30	0.30	0.401	152
70156		38.00	3.00	0.30	0.30	0.594	151
52077		38.00	3.20	0.30	0.30	0.633	152
52075	38.00	4.80	0.30	0.30	0.929	152	
52080	38.00	6.40	0.30	0.30	1.211	152	
33099	> 40mm	40.00	3.00	0.30	0.30	0.626	159
18301		44.50	3.20	0.30	0.30	0.744	177
30675	> 50mm	50.00	1.60	0.30	0.30	0.427	200
20423		50.00	2.00	0.30	0.30	0.531	204
28464		50.00	3.00	0.30	0.30	0.789	199
11350		50.00	6.00	0.30	0.30	1.528	200
19262		50.50	3.00	0.30	0.30	0.797	202
52072		51.00	3.20	0.30	0.30	0.857	203
52073		51.00	4.80	0.30	0.30	1.265	203
52078		51.00	6.40	0.30	0.30	1.659	203
11850	> 60mm	63.00	6.00	0.30	0.30	1.952	252
18422		63.50	3.20	0.30	0.30	1.074	253
00423		63.50	6.40	0.50	0.50	2.092	253
22114		65.00	2.00	0.30	0.30	0.694	260
11163	> 70mm	75.00	3.00	0.30	0.30	1.196	300
29351		76.00	2.00	0.30	0.30	0.813	303
18997		76.00	3.00	0.30	0.30	1.212	303
32945		76.00	4.00	0.30	0.30	1.605	303
52084		76.00	6.40	0.30	0.30	2.527	303
34472	> 100mm	100.00	3.00	0.30	0.30	1.602	399
33290		101.60	10.00	0.30	2.50	5.222	401

TUBING

- Square..... 2
- Rectangular..... 3
- Round..... 4-5

ANGLES

- Equal Leg..... 6
- Unequal Leg..... 7

CHANNELS

- Equal Leg 8-9
- Lipped & Top Hat 10

MISC

- T & H Sections..... 11

BARS

- Flat Bar 12
- Hexagon Bar 13
- Square Bar 13
- Round Bar..... 13

Material Specifications

All material will be Aluminium 6063-T6 unless specified or requested. All lengths can be supplied in 6m lengths. Longer lengths can be supplied on special request.

Surface Finish

All lengths are available in mill finish, powder coated or anodised.

Surface Finish

All lengths are available in mill finish, powder coated or anodised.

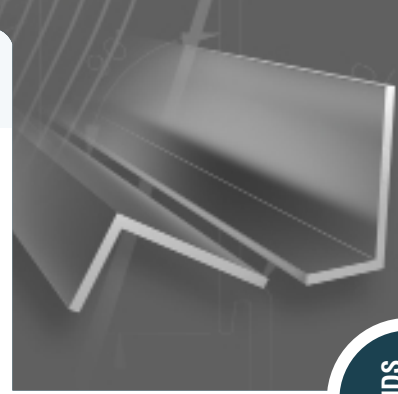

SOLIDS

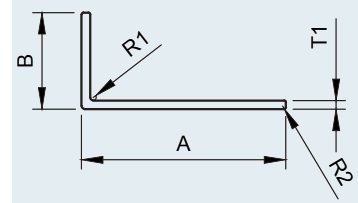

SECTION NO.	RANGE	A	B	T1	R1	R2	Kg/m	PAINT / ANODIZED PERMETER
70140	> 10mm	12.50	9.00	1.50	0.30	0.30	0.081	100
18201		12.70	9.50	1.60	0.50	0.50	0.089	100
25023		15.00	14.00	1.20	0.30	0.30	0.084	100
01295		16.00	9.50	1.60	0.30	0.30	0.103	100
19183		17.50	10.00	1.50	0.30	0.30	0.106	100
18228	> 20mm	21.00	6.50	1.60	0.30	0.79	0.110	100
18287		22.00	8.00	3.20	0.60	0.60	0.232	100
00505		22.00	9.50	1.60	0.30	0.30	0.130	100
18879		22.00	9.50	3.20	0.30	0.30	0.245	100
11164		25.00	12.00	3.00	0.30	0.30	0.276	100
20699		25.00	12.50	1.50	0.30	0.30	0.146	100
70295		25.00	20.00	3.00	0.30	0.30	0.342	100
70158		25.00	50.00	3.00	0.30	0.30	0.586	149
00294		25.50	12.50	3.20	0.30	0.30	0.301	100
18345		25.50	14.50	1.60	0.30	0.30	0.166	100
52174	> 30mm	30.00	20.00	2.50	0.30	0.30	0.322	100
52727		31.20	10.00	1.20	1.00	0.60	0.129	100
02961		32.00	19.00	3.20	0.30	0.30	0.414	101
18664		32.00	25.00	3.20	0.30	0.30	0.466	113
10292		36.00	28.00	2.00	0.30	0.30	0.336	128
20393		36.50	28.50	2.00	0.30	0.30	0.341	129
19319		38.00	13.00	3.20	0.30	0.30	0.414	101
18132		38.00	19.00	3.20	0.30	0.30	0.466	113
10787		38.00	25.00	1.60	0.30	0.30	0.266	126
19477		38.00	25.50	3.20	0.30	0.30	0.523	126
33953	> 40mm	40.00	30.00	2.00	0.30	0.30	0.369	139
70157		44.00	22.00	2.00	0.30	0.30	0.347	131
11953		44.00	22.00	3.00	0.30	0.30	0.512	132
01405		44.50	22.00	2.00	0.30	0.30	0.350	132
00069		44.50	22.00	3.20	0.30	0.30	0.549	132
11165	> 50mm	50.00	25.00	1.50	0.30	0.30	0.299	150
70163		50.00	25.00	1.60	0.30	0.30	0.318	149
18015		51.00	25.50	1.30	0.30	0.30	0.265	152
00819		51.00	25.50	1.50	0.30	0.30	0.304	152
19273		51.00	25.50	1.60	0.30	0.30	0.324	152
10394		51.00	25.50	3.20	0.30	0.30	0.636	152
22025	60mm - 80mm	63.50	19.00	2.50	0.30	0.30	0.542	164
34036		65.00	45.00	3.00	0.30	0.30	0.876	218
11956		75.00	25.00	2.00	0.30	0.30	0.531	200
19428		76.00	18.00	1.50	0.30	0.30	0.376	187
70304		76.00	22.00	2.00	0.30	0.30	0.521	195
20186		76.00	25.00	2.00	0.30	0.30	0.538	202
33912		76.00	38.00	2.00	0.30	0.30	0.607	227
70167		76.00	38.00	3.00	0.30	0.30	0.903	227
19119		76.00	38.00	3.20	0.30	0.30	0.961	227
20402		76.00	38.00	4.80	0.30	0.30	1.421	227
30506		76.00	51.00	4.80	0.30	0.30	1.590	253
29423	76.00	51.00	6.50	0.30	0.30	2.120	253	
52570	> 80mm	80.00	40.00	1.60	0.30	0.30	0.513	240
28206		80.00	50.00	5.00	0.30	0.30	1.692	258
18133		86.00	38.00	2.50	0.30	0.30	0.823	247
18316		89.00	63.50	6.50	0.30	0.30	2.573	304
20417	100mm	100.00	22.00	1.60	0.30	0.30	0.504	242
35394		100.00	40.00	3.00	0.30	0.30	1.114	279
11960		100.00	40.00	4.00	0.30	0.30	1.484	280
34473		100.00	50.00	3.00	0.30	0.30	1.196	299
32923		100.00	50.00	6.00	0.30	0.30	2.343	299
33853		115.00	39.00	5.00	2.50	0.30	2.024	306
20780	> 120mm	120.00	40.00	2.00	0.30	0.30	0.857	320
11409		125.00	50.00	8.00	0.30	0.30	3.623	350
30778		127.00	50.00	2.00	0.30	0.30	0.949	353
36177		135.00	70.00	3.00	0.30	0.30	1.644	410
32924	150mm	150.00	50.00	6.00	0.30	0.30	3.156	399
29236		152.00	76.00	9.50	0.30	0.30	5.629	451

Material Specifications

All material will be Aluminium 6063-T6 unless specified or requested. All lengths can be supplied in 6m lengths. Longer lengths can be supplied on special request.

Surface Finish

All lengths are available in mill finish, powder coated or anodised.

TUBING

- Square 2
- Rectangular 3
- Round 4-5

ANGLES

- Equal Leg 6
- Unequal Leg 7

CHANNELS

- Equal Leg 8-9
- Lipped & Top Hat 10

MISC

- T & H Sections 11

BARS

- Flat Bar 12
- Hexagon Bar 13
- Square Bar 13
- Round Bar 13

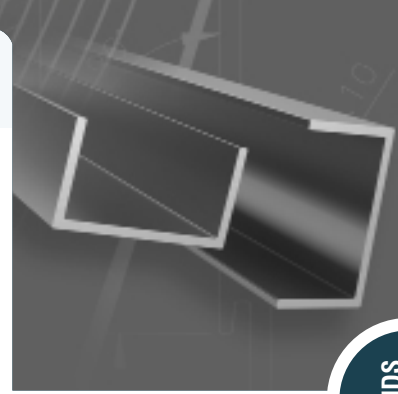

SOLIDS

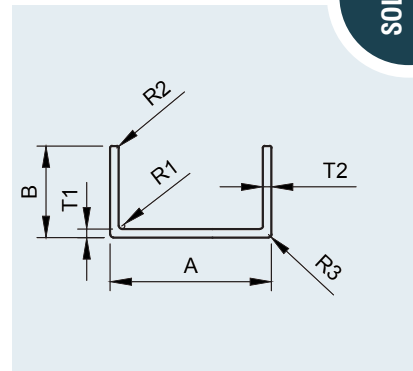

TUBING
 Square 2
 Rectangular 3
 Round 4-5

ANGLES
 Equal Leg 6
 Unequal Leg 7

CHANNELS
 Equal Leg 8-9
 Lipped & Top Hat 10

MISC
 T & H Sections 11

BARS
 Flat Bar 12
 Hexagon Bar 13
 Square Bar 13
 Round Bar 13

SECTION NO.	RANGE	A	B	T1	T2	R1	R2	R3	Kg/m	PAINT / ANODIZED PERMETER
70169	< 10mm	9.00	9.00	1.60	1.60	0.30	0.30	0.30	0.103	100
00478		9.50	9.52	1.60	1.60	0.30	0.30	0.30	0.110	100
21392		9.50	12.70	1.60	1.60	0.30	0.30	0.30	0.137	100
70310	10mm - 20mm	12.00	12.00	1.50	1.50	0.30	0.30	0.30	0.134	100
00184		12.70	9.50	1.50	1.50	0.30	0.30	0.30	0.116	100
10444		12.70	12.70	2.00	2.02	0.30	0.30	0.30	0.188	100
10912		13.00	9.50	1.50	1.50	0.30	0.30	0.30	0.117	100
28126		14.00	16.50	1.75	1.75	0.30	0.30	0.30	0.205	100
20042		15.00	15.90	1.70	1.70	0.30	0.30	0.30	0.204	100
28604		16.00	16.00	1.20	1.20	0.64	0.64	0.60	0.147	100
70329		17.00	15.00	1.20	1.20	0.30	0.30	0.30	0.145	100
19192		19.00	9.50	1.50	1.50	0.30	0.30	0.30	0.142	100
02948		19.00	12.70	1.60	1.60	0.30	0.30	0.30	0.178	100
22881		19.00	21.00	1.20	1.20	0.50	0.50	FULL	0.191	118
11293	19.20	19.20	1.20	1.20	0.30	0.30	0.30	0.179	113	
10642	19.50	19.50	1.30	1.30	0.30	0.30	0.30	0.197	113	
34229	> 20mm	20.00	14.50	1.60	1.60	0.30	0.30	0.30	0.198	100
18461		20.60	19.80	2.00	2.00	0.30	0.30	0.30	0.304	115
21296		21.00	21.00	1.20	1.20	0.30	0.30	FULL	0.197	123
26152		21.00	25.00	2.00	2.00	0.30	0.30	0.30	0.362	132
35993		21.00	50.00	2.00	2.00	0.30	0.30	0.30	0.634	237
70171		21.40	21.00	1.20	1.20	0.30	0.30	0.30	0.198	123
20869		22.00	22.00	2.00	2.00	0.30	0.30	0.30	0.336	128
29363		22.20	14.00	1.20	1.20	0.50	FULL	1.50	0.152	100
32021		22.60	15.50	1.50	1.50	0.30	0.30	0.30	0.205	103
18654		23.00	23.00	1.30	1.30	0.30	0.30	0.30	0.243	134
11368		25.00	12.00	3.00	3.00	0.30	0.30	0.30	0.349	100
19216		25.50	12.70	1.50	1.50	0.30	0.30	0.30	0.195	100
00945		25.50	12.70	3.20	3.20	0.30	0.30	0.30	0.386	100
19064		25.50	22.20	3.20	1.60	0.60	0.60	FULL	0.384	131
52076		25.50	25.50	3.20	3.20	0.30	0.30	0.30	0.608	146
34105		26.00	21.50	1.50	1.50	0.30	0.30	0.30	0.268	134
10308		27.30	25.00	3.00	3.00	0.30	0.30	0.30	0.580	148
20556	28.00	79.00	2.50	2.50	0.30	0.30	0.30	1.227	366	
20018	28.50	16.00	1.50	1.50	0.30	0.30	0.30	0.234	117	
34138	> 30mm	30.00	30.00	3.00	3.00	0.30	0.30	0.30	0.683	173
34139		30.00	50.00	3.00	3.00	0.30	0.30	0.30	1.008	253
18399		31.80	12.50	2.50	2.50	0.30	0.30	0.30	0.351	108
70428		32.00	23.00	1.20	1.20	0.30	1.20	0.30	0.244	153
70429		35.00	25.00	1.40	1.40	0.30	1.40	0.30	0.310	166
28193		35.00	63.00	1.90	1.90	0.30	0.30	0.30	0.810	317
30184		36.00	27.50	2.20	2.20	0.30	0.30	0.30	0.516	177
33157		37.20	19.00	1.60	1.60	0.30	0.30	0.30	0.312	146
00032		38.00	19.00	3.20	3.20	0.30	0.30	0.30	0.604	145
28213	38.00	20.00	1.40	1.40	0.30	0.30	0.30	0.285	152	
19153	38.00	38.00	3.20	3.20	0.30	0.30	0.30	0.934	221	
36867	> 40mm	40.00	15.00	2.00	2.00	0.30	0.30	0.30	0.358	135
26446		43.00	18.00	2.20	1.20	1.60	3.20	0.30	0.350	149
70318		43.50	25.00	1.70	1.70	0.30	0.30	0.30	0.415	183
30401		44.00	17.00	2.00	2.00	0.30	0.30	0.30	0.401	151
32560		44.00	28.00	1.80	1.80	0.30	0.30	0.30	0.470	196
32949		44.00	31.50	1.50	1.50	0.30	0.30	0.30	0.422	210
23224		44.40	19.00	1.60	1.60	0.30	0.60	0.80	0.341	159
72276		46.00	30.00	3.00	3.00	cham	cham	cham	0.779	198
34361		46.50	29.50	2.00	2.00	0.30	0.30	FULL	0.548	205
18446	47.50	19.00	1.50	1.50	0.30	0.30	0.30	0.335	166	
52343	> 50mm	50.00	25.00	3.00	3.00	0.30	0.30	0.30	0.764	193
33208		50.50	20.00	1.50	1.50	0.30	0.30	0.30	0.355	177
00747		51.00	25.40	3.20	3.20	0.30	0.30	0.30	0.828	196
11562		54.50	30.00	2.00	2.00	0.30	0.30	0.30	0.599	225
18658		57.20	32.00	3.20	3.20	0.30	0.30	0.30	0.996	235

Material Specifications

All material will be Aluminium 6063-T6 unless specified or requested. All lengths can be supplied in 6m lengths. Longer lengths can be supplied on special request.

Surface Finish

All lengths are available in mill finish, powder coated or anodised.

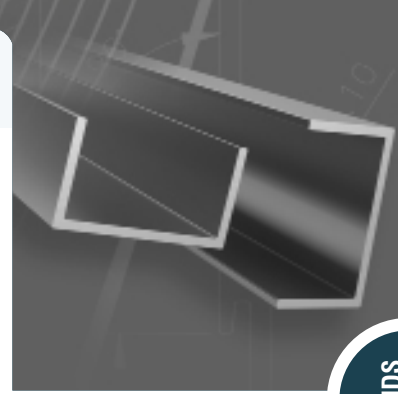

SOLIDS

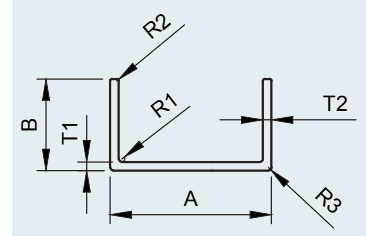

SECTION NO.	RANGE	A	B	T1	T2	R1	R2	R3	Kg/m	PAINT / ANODIZED PERIMETER
34052	> 60mm	60.00	25.00	1.20	1.20	0.30	0.30	0.30	0.350	217
11430		60.00	30.00	1.70	1.70	0.30	0.30	0.30	0.537	237
70323		63.50	32.00	3.00	3.00	0.30	0.30	0.30	0.988	248
52571		64.00	12.00	2.00	2.00	0.30	0.30	0.30	0.455	172
32782	> 70mm	76.00	14.00	1.60	1.60	0.30	0.30	0.30	0.437	204
01835		76.00	38.00	3.00	3.00	2.00	0.30	0.30	1.188	295
0009A		76.00	38.00	6.40	8.00	7.62	0.30	0.30	2.758	284
33547		76.20	20.00	1.70	1.70	0.30	0.50	0.85	0.479	227
34578		78.60	28.00	1.30	1.30	0.30	0.30	0.30	0.465	266
29118	> 80mm	80.00	35.00	2.00	2.00	0.30	0.30	0.30	0.791	294
22209		80.50	21.00	1.50	1.50	0.30	0.30	0.30	0.486	242
23732		82.50	38.00	2.40	2.40	0.30	0.30	0.30	1.000	311
18726		82.50	38.00	3.00	3.00	0.30	0.30	0.30	1.241	310
11903		84.50	35.00	1.80	1.80	0.30	0.30	0.30	0.736	304
18400		92.50	40.00	2.00	2.00	0.30	0.30	0.30	0.914	340
34070	> 100mm	101.00	50.00	3.00	3.00	0.30	0.30	0.30	1.586	395
52363		101.50	25.50	3.20	3.20	0.30	0.30	0.30	1.216	298
0009C		101.50	51.00	6.40	8.00	9.00	0.30	0.30	3.791	386
33815		104.00	42.00	2.00	2.00	0.30	0.30	0.30	0.998	371
21761		105.00	38.00	1.50	1.50	0.30	0.30	FULL	0.724	359
52533		105.50	54.00	6.00	6.00	0.30	0.30	0.30	3.278	414
33058	> 150mm	120.00	45.00	10.00	10.00	0.30	0.30	0.30	5.153	399
32832		127.00	50.00	4.80	4.80	0.30	0.30	0.30	2.830	443
32080		150.00	50.00	2.00	2.00	0.30	0.30	0.30	1.334	495
33248		152.40	76.20	10.00	10.00	5.00	2.50	2.50	7.732	579
22810		152.40	76.20	9.50	12.70	2.00	0.30	0.30	8.523	590
26089		152.70	54.00	10.50	10.50	10.00	1.00	1.00	6.939	490

TUBING

- Square 2
- Rectangular 3
- Round 4-5

ANGLES

- Equal Leg 6
- Unequal Leg 7

CHANNELS

- Equal Leg 8-9
- Lipped & Top Hat 10

MISC

- T & H Sections 11

BARS

- Flat Bar 12
- Hexagon Bar 13
- Square Bar 13
- Round Bar 13

Material Specifications

All material will be Aluminium 6063-T6 unless specified or requested. All lengths can be supplied in 6m lengths. Longer lengths can be supplied on special request.

Surface Finish

All lengths are available in mill finish, powder coated or anodised.



SOLIDS

LIPPED CHANNEL

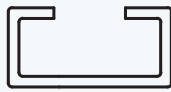

SECTION NO.	RANGE	A	B	C	D	T1	T2	T3	R1	R2	Kg/m	PAINT / ANODIZED PERIMETER
19921	20mm-50mm	18.40	5.90	11.00	3.70	1.20	1.20	1.20	0.30	1.00	0.107	100
31064		30.00	9.00	12.00	9.00	2.00	2.00	2.00	0.30	0.30	0.314	118
14052		35.00	15.00	15.00	10.00	2.50	2.50	2.50	0.30	0.30	0.508	155
19835		41.32	4.76	33.34	3.99	1.62	1.62	2.40	0.30	0.30	0.236	105
70722		50.00	30.00	20.00	15.00	5.00	5.00	5.00	0.30	0.30	1.627	248

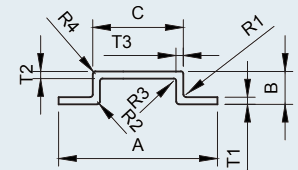
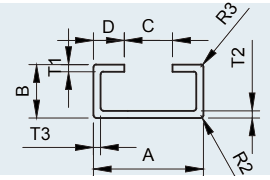

TOP HAT PROFILES



SECTION NO.	RANGE	A	B	C	T1	T2	T3	R1	R2	R3	Kg/m	PAINT / ANODIZED PERIMETER
21426		57.20	28.50	23.80	2.20	2.20	2.50	0.30	2.50	0.30	0.669	218
32137		75.00	19.00	47.60	2.00	2.00	0.30	0.30	0.30	0.30	0.591	220

TUBING

- Square 2
- Rectangular 3
- Round 4-5

ANGLES

- Equal Leg 6
- Unequal Leg 7

CHANNELS

- Equal Leg 8-9
- Lipped & Top Hat 10

MISC

- T & H Sections 11

BARS

- Flat Bar 12
- Hexagon Bar 13
- Square Bar 13
- Round Bar 13

Material Specifications

All material will be Aluminium 6063-T6 unless specified or requested. All lengths can be supplied in 6m lengths. Longer lengths can be supplied on special request.

Surface Finish

All lengths are available in mill finish, powder coated or anodised.

T-SECTIONS

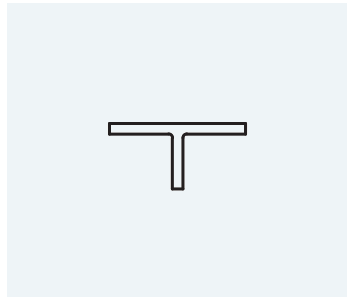

SECTION NO.	RANGE	A	B	T1	T2	R	Kg/m	PAINT / ANODIZED PERIMETER
35172	10mm	8.00	13.50	1.20	1.20	0.30	0.065	100
19461		9.50	20.00	1.50	1.50	0.30	0.111	100
22651		19.00	19.00	3.00	3.00	0.30	0.285	100
32846	> 20mm	20.00	33.50	1.50	2.00	0.30	0.254	106
36384		22.00	42.00	1.90	1.90	0.30	0.320	127
25022		22.00	42.00	2.00	2.00	0.30	0.335	128
70376		22.00	45.00	2.00	2.00	0.30	0.352	133
22324		25.00	25.00	1.60	1.60	0.30	0.209	100
02169		25.50	25.50	3.20	3.20	0.30	0.415	101
31095	> 30mm	30.00	20.00	2.00	2.00	0.30	0.260	100
28974		38.00	12.70	1.20	1.20	0.30	0.160	100
10963		38.00	38.00	1.26	1.26	0.30	0.255	152
71646		38.00	38.00	2.00	2.00	0.30	0.403	152
20598		38.00	38.00	3.00	3.00	0.30	0.593	151
23085		38.00	38.00	4.80	4.48	5.84	0.965	146
34582	> 40mm	40.00	20.00	1.50	1.50	0.30	0.237	119
36593		50.00	25.00	2.00	2.00	1.00	0.393	147
70377		50.00	50.00	3.00	3.00	0.30	0.789	199
33705		98.50	50.80	3.20	3.20	0.30	1.267	296
72275		120.00	50.00	3.00	2.50	6.00	1.228	334

H-SECTIONS

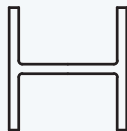

SECTION NO.	RANGE	A	B	T1	T2	R1	Kg/m	PAINT / ANODIZED PERIMETER
11775	< 20mm	15.50	6.50	1.20	1.20	0.30	0.085	100
32134		16.00	16.00	1.60	1.60	0.30	0.192	100
22879		19.00	21.00	1.20	1.20	0.50	0.191	120
11290		19.20	20.00	1.20	1.20	0.30	0.185	116
21297	> 20mm	21.00	21.00	1.20	1.20	0.30	0.196	121
10643		48.50	27.50	2.00	2.00	0.30	0.540	201
18994		63.50	44.50	3.00	3.00	3.00	1.000	293

Material Specifications

All material will be Aluminium 6063-T6 unless specified or requested. All lengths can be supplied in 6m lengths. Longer lengths can be supplied on special request.

Surface Finish

All lengths are available in mill finish, powder coated or anodised.

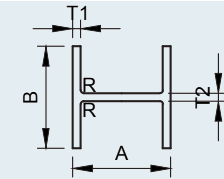
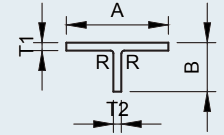

SOLIDS

TUBING

- Square 2
- Rectangular 3
- Round 4-5

ANGLES

- Equal Leg 6
- Unequal Leg 7

CHANNELS

- Equal Leg 8-9
- Lipped & Top Hat 10

MISC

- T & H Sections 11

BARS

- Flat Bar 12
- Hexagon Bar 13
- Square Bar 13
- Round Bar 13

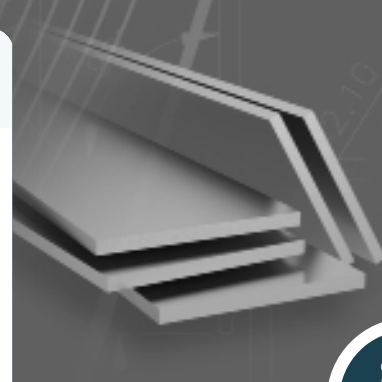

SOLIDS

SECTION NO.	RANGE	A	B	R1	Kg/m	PAINT / ANODIZED PERIMETER	SECTION NO.	RANGE	A	B	R1	Kg/m	PAINT / ANODIZED PERIMETER		
30052		7.60	6.80	1.00	0.137	100	70355		50.00	2.00	0.30	0.271	103		
19145	> 10mm	10.00	4.00	0.30	0.108	100	11171	> 50mm	50.00	3.00	0.30	0.407	106		
30825		12.00	2.00	0.30	0.065	100	32598		50.00	4.20	0.30	0.569	107		
70254		12.00	3.00	0.30	0.097	100	20861		50.00	6.00	0.30	0.804	112		
20822		12.40	3.00	0.30	0.101	100	32297		50.00	16.00	0.30	2.169	131		
18023		12.70	3.20	FULL	0.104	100	52394		50.00	25.80	0.30	3.498	152		
10742		12.70	3.20	0.30	0.110	100	18501		50.80	2.00	0.30	0.274	105		
19577		12.70	4.80	0.30	0.165	100	52074		51.00	3.20	0.30	0.437	108		
10569		15.90	3.20	0.30	0.138	100	11299		51.00	4.80	0.30	0.661	112		
22811		16.00	1.60	0.50	0.069	100	52071		51.00	6.40	0.30	0.885	114		
21197		16.00	3.00	0.30	0.130	100	33291		51.00	6.40	2.00	0.866	111		
36439		16.00	3.00	FULL	0.125	100	0250Y		51.00	9.50	0.30	1.314	120		
22812		18.00	1.60	0.30	0.078	100	0250B		51.00	12.70	0.30	1.757	127		
31919		19.00	2.00	0.30	0.102	100	18948		51.00	25.50	0.30	3.527	152		
18450		19.00	2.40	0.30	0.123	100									
19342		19.00	3.00	0.30	0.155	100	11411		> 60mm	60.00	10.00	FULL	1.569	131	
11732		19.00	3.20	0.30	0.165	100	34656			62.00	21.00	5.00	3.473	158	
0034H	19.00	4.80	0.30	0.247	100	18656	63.50	3.20		0.30	0.550	132			
0250F	19.00	6.40	0.30	0.330	100	0460U	63.50	12.70		0.30	2.187	152			
19014	19.00	9.50	0.30	0.489	100	04068	63.50	15.90		0.30	2.738	158			
22813	> 20mm	20.00	1.60	0.30	0.087	100	19733	63.50	25.50	0.30	4.391	177			
11404		20.00	2.00	0.30	0.108	100	28267	64.00	12.00	0.30	2.073	151			
70340		20.00	6.00	0.30	0.325	100	32819	> 70mm	70.00	8.00	0.30	1.518	156		
31930		22.00	2.00	0.30	0.119	100	26375		75.00	1.30	0.30	0.264	153		
0034J		22.20	3.20	0.30	0.192	100	22261		75.00	1.50	0.30	0.305	153		
28560		23.00	1.70	0.30	0.105	100	52087		75.00	1.90	FULL	0.384	152		
70256		24.00	2.80	0.30	0.182	100	70360		76.00	1.50	0.30	0.309	154		
28934		25.00	1.50	0.30	0.102	100	11840		76.00	1.50	FULL	0.307	154		
31989		25.00	2.00	0.30	0.135	100	28461		76.00	13.00	0.30	2.679	177		
18223		25.00	2.50	0.30	0.169	100	18642		76.20	1.90	0.30	0.392	156		
10108		25.00	3.00	0.30	0.203	100	18309		76.20	3.20	0.30	0.661	158		
33100		25.00	6.00	0.30	0.406	100	10170		76.20	6.40	0.30	1.323	165		
28340		25.00	9.50	0.30	0.644	100	0250J	76.20	9.50	0.30	1.963	171			
10242		25.00	12.00	0.30	0.813	100									
52085		25.50	3.20	0.30	0.220	100	20746	> 80mm	80.00	1.60	0.30	0.347	163		
35568		25.50	3.80	0.30	0.263	100	30682		80.00	5.00	0.30	1.084	169		
0034A	25.50	4.80	0.30	0.332	100	24981	80.00		8.00	0.30	1.728	176			
10390	25.50	6.40	0.30	0.442	100	21119	80.00		10.00	0.30	2.164	179			
31406	25.50	9.50	0.30	0.657	100	11176	80.00		45.00	0.30	9.743	245			
10901	25.50	12.70	0.30	0.878	100	18314	89.00	9.50	0.30	2.293	196				
21091	29.80	5.50	0.30	0.477	100										
29117	> 30mm	30.00	2.00	0.30	0.163	100	70362	90mm	95.00	15.00	0.30	3.865	219		
21887		30.00	3.00	0.30	0.243	100	25029	97.00	2.00	0.30	0.524	198			
29476		30.00	5.00	0.30	0.406	100									
33962		30.00	10.00	0.30	0.813	100	27939	100mm - 180mm	100.00	3.00	0.30	0.809	206		
11731		31.80	3.20	0.30	0.275	100	70962		100.00	6.00	0.30	1.627	212		
18370		31.80	6.40	0.30	0.551	100	34260		100.00	8.00	0.30	2.168	214		
20260		31.80	4.80	0.30	0.414	100	33987		100.00	8.00	1.00	2.169	216		
31419		31.80	9.50	0.30	0.819	100	34262		100.00	10.00	1.30	2.708	218		
21126		34.00	8.00	0.30	0.737	100	33017		100.00	12.00	0.30	3.255	223		
33049		35.00	3.20	0.30	0.304	100	28402		100.00	15.00	0.30	4.070	229		
70352		38.00	1.50	0.30	0.154	100	32800		100.00	16.00	0.30	4.339	232		
31920		38.00	2.00	0.30	0.205	100	11781		101.00	9.50	1.00	2.599	221		
11733		38.00	3.20	0.30	0.330	100	23812		101.50	2.00	0.50	0.551	207		
0460K		38.00	4.80	0.30	0.494	100	21118	120.00	15.00	1.60	4.876	268			
72223		38.00	6.00	0.30	0.618	100	19554	127.00	9.50	0.50	3.271	272			
0034C		38.00	6.40	0.30	0.659	100	36635	150.00	12.20	0.30	4.963	324			
0250U	38.00	12.70	0.30	1.309	101	36071	150.00	15.00	1.00	6.100	215				
0034S	38.10	9.50	0.30	0.979	100	10985	160.00	10.00	3.00	4.318	335				
25025	> 40mm	40.00	2.50	0.30	0.271	100	21449	180.00	6.00	0.30	2.929	372			
34355		40.00	5.00	0.30	0.542	100									
19724		40.00	8.00	0.30	0.868	100									
20098		40.00	20.00	0.30	2.169	119									
36450		44.50	16.50	0.30	1.991	121									
11609		46.00	1.20	0.30	1.490	100									

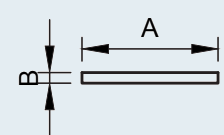

TUBING
 Square 2
 Rectangular 3
 Round 4-5

ANGLES
 Equal Leg 6
 Unequal Leg 7

CHANNELS
 Equal Leg 8-9
 Lipped & Top Hat 10

MISC
 T & H Sections 11

BARS
 Flat Bar 12
 Hexagon Bar 13
 Square Bar 13
 Round Bar 13

Material Specifications
 All material will be Aluminium 6063-T6 unless specified or requested. All lengths can be supplied in 6m lengths. Longer lengths can be supplied on special request.

Surface Finish
 All lengths are available in mill finish, powder coated or anodised.

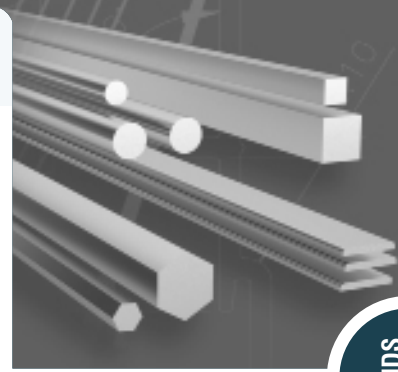

SOLIDS

ROUND BAR

SECTION NO.	RANGE	A	Kg/m	PAINT / ANODIZED PERIMETER
70192	< 10mm	4.80	0.049	100
20041		6.00	0.077	100
11921		6.35	0.085	100
33029		7.00	0.104	100
71156		8.00	0.136	100
52474		9.50	0.192	100
52068		> 10mm	10.00	0.213
52326	12.00		0.306	100
22044	12.70		0.343	100
31413	14.00		0.417	100
22233	15.00		0.479	100
52331	16.00		0.545	100
11854	18.00		0.690	100
11873	19.00	0.769	100	
52327	> 20mm	20.00	0.852	100
28459		22.00	1.031	100
52098		23.00	1.126	100
52328		25.00	1.331	100
28539		28.00	1.670	100
33609	> 30mm	30.00	1.917	100
52369		31.80	2.154	100
28066		32.00	2.171	101
52036		32.60	2.263	103
31421		33.30	2.362	104
52370		35.00	2.610	110
11651		38.00	3.076	120
28125	> 40mm	40.00	3.392	126
30634		42.00	3.757	132
52742		45.00	4.313	141
31416		49.00	5.114	153
22497	> 50mm	50.00	5.327	157
34072		60.00	7.750	190
32418		66.00	9.279	207
31417		75.00	11.982	235

SQUARE BAR

SECTION NO.	RANGE	A	Kg/m	PAINT / ANODIZED PERIMETER
22050		9.50	0.245	100
70519	10mm	12.00	0.390	100
22051		12.70	0.437	100
22248		16.00	0.694	100
31407		17.00	0.783	100
22052		19.00	0.979	100
10092	20mm	25.00	1.694	100
22053		25.50	1.763	101
20049	30mm	31.80	2.743	127
10093		32.00	2.775	128
52373		38.00	3.916	151
34759		50.00	6.781	200

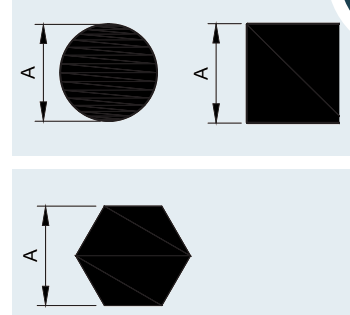

HEXAGON BARS

SECTION NO.	RANGE	A	Kg/m	PAINT / ANODIZED PERIMETER
71491		6.00	0.084	100
22253		25.70	1.551	100

Material Specifications

All material will be Aluminium 6063-T6 unless specified or requested. All lengths can be supplied in 6m lengths. Longer lengths can be supplied on special request.

Surface Finish

All lengths are available in mill finish, powder coated or anodised.

TUBING

- Square..... 2
- Rectangular..... 3
- Round..... 4-5

ANGLES

- Equal Leg..... 6
- Unequal Leg..... 7

CHANNELS

- Equal Leg 8-9
- Lipped & Top Hat 10

MISC

- T & H Sections..... 11

BARS

- Flat Bar 12
- Hexagon Bar 13
- Square Bar 13
- Round Bar..... 13