



2021

STANDARD PROFILE CATALOGUE

TUBING

- Square..... 2
- Rectangular..... 3
- Round..... 4-5

ANGLES

- Equal Leg..... 6
- Unequal Leg..... 7

CHANNELS

- Equal Leg 8-9
- Lipped & Top Hat 10

MISC

- T & H Sections..... 11

BAR

- Flat Bar 12
- Hexagon Bar 13
- Square Bar..... 13
- Round Bar..... 13



WISPECO EXTRUSION DESIGN

The extruded sections shown in this catalogue are in general demand and available to any customer. Thousands of other profiles have been designed for customers and specifiers to suit specific purposes.

Wispeco will be pleased to assist you with the design of aluminium extrusions to suit your specific requirements.

FINISHING OF ALUMINIUM EXTRUSIONS

Wispeco Aluminium is able to offer a variety of finishes for aluminium extrusions which includes anodising and powder coating.

ENQUIRIES

Johannesburg (011) 389-0000
Durban (031) 579-8337
Cape Town (021) 959-5400

ALUMINIUM ALLOYS

DESIGNATION	Description	Finishing	Available Forms				Typical Uses
			Anodising Response	Shapes	Tubing	Bars	
1350	Electrically pure aluminium with conductivity of 60% of I.A.C.S.	-	All	✓	FLAT		Busbar. All electrical conductor requirements.
6063	Sustainable for intricate sections of medium strength. Forms well in "F" and "T1" conditions. High Corrosion resistance. Good surface finish.	Very Good	All	✓		✓	Architectural members such as window frames and shop-fitting shapes. Irrigation tubes. General Purpose Use.
6463	A modified 6063. Responds well to chemical brightening.	Very Good	All	✓		✓	Bright trim. Extruded reflector shapes.
6101	The best combination of electrical and mechanical conductor properties. Conductivity 55% of I.A.C.S.	-	Structural	✓	✓	✓	Busbar. Electrical conductors and fittings.
6061	General purpose structural alloy. Good mechanical properties. Good corrosion resistance and weldability.	Good	Structural	✓	✓	✓	Structural applications of all kinds. Road and rail transport. Mine cages, cranes, bridges, towers, roof trusses, etc.
6082	General purpose structural alloy. Good mechanical properties. Good corrosion resistance and weldability.	Good	Structural	✓	✓	✓	Bolts, nuts, drive screws, etc.
6005	Medium strength alloy.	Fair	Limited	✓	✓	✓	Ladders, Design applications requiring characteristics between 6063 and 6082.

This manual has been compiled to assist both the stockist and the manufacturer.

Every effort has been made to ensure accuracy of data, but no responsibility can be accepted for errors or omissions due to our continuous policy of research and development.

Wispeco Aluminium reserves the right to alter or amend dimensions and/or specifications without prior notice.

TEMPER DESIGNATIONS

DESIGNATION	Approximate Equivalent	Description
F	M M	As fabricated. Applies to the product of shaping process in which no special control over thermal conditions or strain-hardening is employed
T1	TB W	Cooled from an elevated temperature shaping process and naturally aged to substantially stable condition
T5	TE P	Cooled from an elevated temperature shaping process and then artificially aged
T6	TF WP	Solution heat-treated and then artificially aged

NOTE: 1350 is a non-heat treatable alloy and is always supplied in the "F" Condition.

CHEMICAL COMPOSITION (NOMINAL)

ALLOY	Si	Fe	Cu	Mn	Mg	Cr	Zn	Ti
6063	0.20 - 0.60	0.35	0.10	0.10	0.45 - 0.90	0.10	0.10	0.10
6351	0.70 - 1.30	0.50	0.10	0.40 - 0.80	0.40 - 0.80	-	0.20	0.20
6463	0.20 - 0.60	0.15	0.20	0.05	0.45 - 0.90	-	0.05	0.05
1350	0.10	0.40	0.05	0.01	-	0.01	0.05	-
6101	0.30 - 0.70	0.50	0.10	0.03	0.35 - 0.80	0.03	0.10	-
6005	0.60 - 0.90	0.35	0.10	0.10	0.40 - 0.60	0.10	0.10	0.10
6061	0.40 - 0.80	0.40	0.15 - 0.40	0.20 - 0.35	0.70 - 1.00	0.10	0.20	0.20

NOTES: 1. Balance Aluminium (Al)
2. Except where range is shown, all values are maxima
3. Material is available to various international standards

TUBING

Square 2
Rectangular..... 3
Round..... 4-5

ANGLES

Equal Leg..... 6
Unequal Leg..... 7

CHANNELS

Equal Leg 8-9
Lipped & Top Hat 10

MISC

T & H Sections..... 11

BARS

Flat Bar 12
Hexagon Bar 13
Square Bar 13
Round Bar..... 13

COPYRIGHT

DESIGNS, DRAWINGS AND SPECIFICATIONS AND THE COPYRIGHT THEREIN ARE THE PROPERTY OF WISPECO PTY LTD. ALL THE DIES ARE REGISTERED AND RESERVED.



HOLLOW

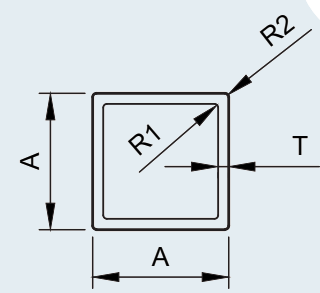

SECTION NO.	RANGE	A	T	R1	R2	Kg/m	PAINT PERIMETER	ANODIZED PERIMETER
42357	> 10mm	11.80	1.20	0.30	0.30	0.138	100	100
50055		12.00	1.20	0.30	0.30	0.140	100	100
55783		12.70	1.50	0.30	0.30	0.182	100	100
42326		15.00	1.20	0.30	0.30	0.179	100	100
57018		16.00	1.20	0.30	0.30	0.193	100	100
53664		16.00	1.60	0.30	0.30	0.248	100	100
42912		18.00	1.20	0.30	0.30	0.219	100	103
54060		19.00	1.50	0.30	0.30	0.285	100	108
50060		19.00	1.60	0.30	0.30	0.302	107	107
50059		19.00	3.20	0.30	0.30	0.548	100	101
42406	> 20mm	20.00	1.10	0.30	0.30	0.226	100	116
55884		20.00	1.10	3.90	5.00	0.202	100	104
52493		20.00	1.30	0.30	1.00	0.261	100	113
42179		20.00	1.50	0.60	0.60	0.301	100	114
10871		20.00	1.50	0.30	0.30	0.301	100	114
00193		20.00	1.60	0.30	0.30	0.319	100	113
56060		20.00	2.00	0.30	0.30	0.391	100	111
50064		21.00	1.20	0.30	0.30	0.257	100	120
42435		21.00	1.30	0.40	0.40	0.277	100	139
00012		22.20	2.00	1.20	3.20	0.418	100	119
50382		22.50	2.00	0.75	2.50	0.432	100	122
50065		24.00	1.20	0.30	0.30	0.296	100	138
42390		24.00	1.30	0.30	0.30	0.319	100	139
58881		25.00	1.20	0.30	0.30	0.310	100	144
50347		25.00	1.30	2.00	1.30	0.343	100	143
56616		25.00	1.40	0.30	0.30	0.358	100	143
50066		25.00	1.50	0.30	0.30	0.382	100	143
42178		25.00	1.50	0.30	0.80	0.381	100	142
54927		25.00	1.60	0.30	0.30	0.405	100	143
55408		25.00	2.00	0.90	0.90	0.500	100	139
53916		25.00	2.00	4.00	6.00	0.452	100	129
50609		25.00	3.00	0.30	0.30	0.716	100	137
10628		25.40	2.00	0.30	0.30	0.507	102	145
00022		25.40	3.18	0.70	3.96	0.731	100	133
55162		25.90	1.90	0.30	0.30	0.494	103	147
56693		27.20	1.50	1.00	0.30	0.416	105	155
11433		> 30mm	30.00	1.60	0.30	0.30	0.492	120
42886	30.00		2.00	0.30	0.50	0.608	120	172
56692	31.00		1.60	0.30	0.30	0.510	124	180
00101	31.80		3.20	0.63	0.63	0.993	126	176
55144	33.60		1.50	0.30	0.30	0.522	134	195
10223	38.00		1.70	1.00	0.30	0.667	152	221
00041	38.00		2.00	0.30	1.27	0.777	150	218
42274	38.00		3.00	1.00	2.00	1.132	149	212
50070	38.00	3.00	0.30	0.30	1.139	151	215	
55899	> 40mm	40.00	2.00	0.30	0.30	0.825	160	232
56965		40.00	2.50	0.30	0.30	1.017	160	230
56207		40.00	3.00	0.30	0.30	1.204	160	228
42938		44.00	3.00	2.00	0.50	1.343	175	250
53996		44.00	3.00	3.00	0.30	1.355	176	250
58335	50mm	50.00	1.50	0.30	0.30	0.789	200	294
56655		50.00	2.00	0.50	2.50	1.028	196	287
11173		50.00	3.00	0.30	0.30	1.529	200	288
56066		50.00	6.00	0.30	0.30	2.864	200	275
00256		50.80	3.20	1.60	1.60	1.653	200	288
56924	> 60mm	60.00	2.00	0.30	0.30	1.258	240	352
56081		60.00	3.00	0.30	0.30	1.855	239	347
42145		63.50	6.40	1.60	6.36	3.877	243	343
56121	> 70mm	70.50	2.50	0.30	0.30	1.830	278	409
11517		76.00	2.00	0.30	0.30	1.605	304	448
50075		76.20	1.70	0.30	0.30	1.374	304	450
42371		77.80	2.00	0.30	0.30	1.644	311	458
55210	> 100mm	100.00	2.00	0.30	0.30	2.126	399	591
13029		100.00	3.50	0.30	0.30	3.644	400	586
55906		100.00	6.00	0.30	0.30	6.119	399	575
55126		114.50	2.00	0.40	0.40	2.441	457	678

Material Specifications

All material will be Aluminium 6063-T6 unless specified or requested. All lengths can be supplied in 6m lengths. Longer lengths can be supplied on special request.

Surface Finish

All lengths are available in mill finish, powder coated or anodised.

TUBING

- Square 2
- Rectangular..... 3
- Round..... 4-5

ANGLES

- Equal Leg..... 6
- Unequal Leg..... 7

CHANNELS

- Equal Leg 8-9
- Lipped & Top Hat 10

MISC

- T & H Sections..... 11

BARS

- Flat Bar 12
- Hexagon Bar 13
- Square Bar 13
- Round Bar..... 13



HOLLOW

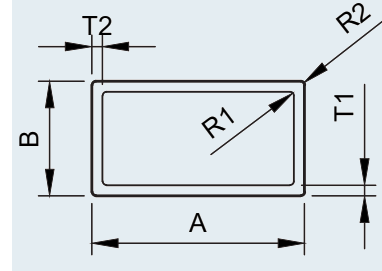

SECTION NO.	RANGE	A	B	T1	T2	R1	R2	Kg/m	PAINT PERIMETER	ANODIZED PERIMETER
58171	> 10mm	15.00	10.00	1.50	1.50	0.30	0.30	0.179	100	100
11922		18.00	12.00	1.20	1.20	0.30	0.30	0.179	100	100
55237		18.00	12.00	1.50	1.50	1.00	0.30	0.220	100	100
42593	> 20mm	20.00	10.00	1.20	1.20	0.30	0.30	0.179	100	100
55351		24.00	18.00	1.20	1.20	0.30	0.30	0.258	100	120
53661		24.00	18.00	1.20	1.20	2.30	3.50	0.240	100	114
11499		25.00	12.00	1.50	1.50	0.30	0.30	0.277	100	104
54935		25.00	15.00	1.30	1.30	0.30	0.30	0.263	100	114
54237		25.00	20.00	2.00	2.00	2.00	0.30	0.435	100	123
54632	28.50	12.50	1.70	1.70	0.80	1.40	0.341	100	113	
42297	> 30mm	30.00	20.00	1.20	1.20	3.80	5.00	0.285	100	133
11254		30.00	20.00	1.20	1.20	1.30	2.50	0.299	100	140
52102		33.00	20.00	1.20	1.40	1.60	3.00	0.333	101	148
42104		33.00	20.00	1.30	1.30	2.25	3.50	0.338	100	146
54213		35.00	25.00	2.00	2.00	0.30	0.30	0.607	120	171
42701		35.00	25.40	1.60	1.60	0.80	2.40	0.485	117	171
57374		35.00	25.50	1.40	1.40	0.50	2.00	0.429	118	172
00269		35.30	25.50	1.60	1.60	0.30	0.30	0.499	121	175
50900		36.00	20.00	3.00	3.00	0.30	0.30	0.817	111	155
42484		38.00	20.00	1.30	1.30	0.50	1.00	0.388	115	168
55097		38.00	25.00	1.50	1.50	0.30	0.30	0.488	125	182
55007		38.00	25.00	2.00	2.00	0.30	0.30	0.640	125	180
53801		38.00	25.00	2.40	2.40	0.30	0.30	0.757	125	178
56621		> 40mm	40.00	20.00	2.00	2.00	0.30	0.30	0.608	119
10939	40.00		29.50	1.50	1.50	0.30	0.30	0.549	120	174
55559	40.00		30.00	2.50	2.50	0.30	0.30	0.881	139	199
42197	43.00		16.00	1.90	1.90	0.30	0.30	0.569	118	170
52099	45.00		20.00	1.40	1.40	1.50	3.00	0.456	125	184
53295	48.00	22.00	1.20	1.50	0.50	2.00	0.463	136	200	
56805	> 50mm	50.00	12.00	2.00	2.00	0.30	0.30	0.629	123	177
58398		50.00	20.00	2.00	2.00	0.30	0.30	0.716	139	201
50101		50.00	25.00	1.50	1.50	0.30	0.30	0.585	149	218
53111		50.00	25.00	2.00	2.00	0.30	0.30	0.770	150	217
53917		50.00	25.00	2.00	2.00	4.00	6.00	0.723	140	204
11175		50.00	25.00	2.50	2.50	0.30	0.30	0.949	149	214
42645		50.00	25.00	3.00	3.00	3.50	6.00	1.053	139	199
57620		50.00	25.00	3.20	3.20	0.30	0.30	1.190	212	150
10940		50.00	29.50	1.50	1.50	0.30	0.30	0.622	159	233
54306		50.00	30.00	2.00	2.00	0.30	0.30	0.824	159	231
13117		51.00	20.50	1.50	1.50	1.50	3.00	0.542	138	202
42070		51.00	25.50	2.50	2.50	0.70	0.70	0.968	151	219
56347		51.00	25.50	4.00	4.00	0.30	2.00	1.477	149	209
42619		57.00	20.80	2.00	2.00	0.80	0.80	0.801	154	223
53384	> 60mm	60.00	40.00	3.00	3.00	0.30	0.75	1.529	199	287
13038		60.50	30.50	1.80	1.80	0.50	1.20	0.850	180	264
00247		63.50	31.80	2.30	2.30	0.30	0.30	1.131	191	268
10941		67.50	29.50	1.70	1.70	0.30	0.30	0.861	194	284
11493	> 70mm	76.00	38.00	2.00	2.00	0.30	0.30	1.193	228	334
54156		76.00	60.00	2.00	2.00	0.30	0.30	1.432	271	399
42628		76.20	38.00	3.20	3.20	0.75	0.75	1.870	227	329
56300		76.00	51.00	4.00	4.00	2.00	4.00	2.554	247	356
10942	> 80mm	80.50	29.50	1.80	1.80	0.30	0.30	1.038	221	325
42608		82.50	31.50	1.70	2.60	6.00	7.50	1.110	215	315
56257		82.50	31.80	1.90	3.00	4.75	6.35	1.264	218	319
10807		89.00	22.00	2.50	2.50	0.30	0.30	1.436	222	323
58819	> 90mm	97.00	25.00	1.30	1.30	0.30	0.30	0.842	243	360
42194		98.00	18.00	2.00	2.00	0.30	0.30	1.215	231	339
11321	> 100mm	100.00	29.50	2.00	2.00	0.30	0.30	1.361	259	381
42534		100.00	38.00	2.00	2.00	1.50	0.30	1.458	276	405
54126		100.00	50.00	2.00	2.00	0.30	0.30	1.583	299	440
55842		100.00	50.00	3.00	3.00	0.30	0.30	2.343	299	437
00414		101.00	50.00	4.50	4.50	0.63	1.78	3.461	299	431
00803		101.50	44.50	3.20	3.20	0.30	0.38	2.428	292	426
42505		101.50	45.00	1.80	1.80	0.30	1.50	1.390	291	431
56350		101.50	51.00	3.25	3.25	0.30	2.00	2.565	301	441
55163		101.50	76.00	2.00	2.00	0.30	2.00	1.873	352	522
42829		110.00	40.00	3.00	3.00	0.30	0.30	2.435	300	437
42722	120.00	80.00	4.00	4.00	3.00	4.00	4.149	393	575	
57942	> 110mm	130.00	70.00	2.00	2.00	0.30	0.30	2.126	399	591
55951		140.00	44.00	3.00	3.00	0.30	0.30	2.897	367	539
42409		146.00	32.00	3.00	3.00	0.30	0.30	2.800	355	521
42533		150.00	38.00	2.00	2.00	1.50	0.30	2.001	376	554
58101		150.00	50.00	1.80	1.80	0.30	0.30	1.918	400	592
55209		150.00	50.00	2.00	2.00	0.30	0.30	2.126	399	591
55124		150.00	50.00	3.00	3.00	0.40	0.40	3.157	399	587
42317		163.00	50.00	3.00	3.00	0.30	0.30	3.368	425	626

Material Specifications

All material will be Aluminium 6063-T6 unless specified or requested. All lengths can be supplied in 6m lengths. Longer lengths can be supplied on special request.

Surface Finish

All lengths are available in mill finish, powder coated or anodised.

TUBING

- Square 2
- Rectangular 3
- Round 4-5

ANGLES

- Equal Leg 6
- Unequal Leg 7

CHANNELS

- Equal Leg 8-9
- Lipped & Top Hat 10

MISC

- T & H Sections 11

BARS

- Flat Bar 12
- Hexagon Bar 13
- Square Bar 13
- Round Bar 13

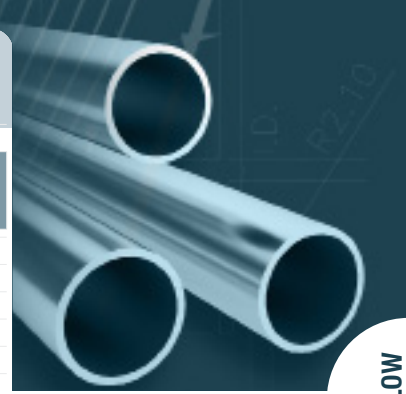

HOLLOW

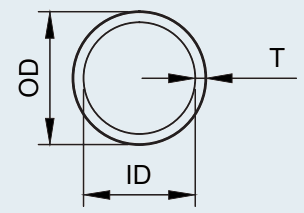

SECTION NO.	RANGE	OD	T	ID	Kg/m	PAINT PERIMETER	ANODIZED PERIMETER	SECTION NO.	RANGE	OD	T	ID	Kg/m	PAINT PERIMETER	ANODIZED PERIMETER	
50128	<10mm	8.00	1.20	5.60	0.069	100	100	50251	<30mm	25.50	5.00	15.50	0.873	100	104	
55146		9.00	1.20	6.56	0.080	100	100	53614		25.50	5.20	15.10	0.899	100	104	
50130		9.50	1.20	7.10	0.084	100	100	42356		26.30	1.20	23.90	0.257	100	121	
50131		9.70	1.30	7.10	0.093	100	100	54887		26.30	5.60	15.10	0.988	100	107	
55721		9.80	1.20	7.40	0.087	100	100	55098		26.80	2.00	22.80	0.423	100	120	
								42578		27.30	3.00	21.30	0.621	100	120	
50132	>10mm	10.00	1.20	7.60	0.090	100	100	55905		27.80	1.40	25.00	0.315	100	126	
50133		10.00	1.50	7.00	0.109	100	100	56510		28.00	1.50	25.00	0.339	100	127	
42865		10.00	1.60	6.80	0.114	100	100	50160		28.50	1.60	25.30	0.367	100	129	
55317		10.00	2.80	4.30	0.173	100	100	56255		28.60	1.20	26.20	0.280	100	131	
50134		12.00	2.60	6.80	0.208	100	100	42726		28.60	1.60	25.40	0.360	100	130	
11552		12.20	1.20	9.80	0.112	100	100	55649		29.00	1.20	26.60	0.284	100	133	
50135		12.70	1.20	10.30	0.117	100	100	54066		29.20	1.20	27.10	0.286	100	133	
42676		12.70	1.65	9.40	0.155	100	100	52566	29.60	4.80	20.00	1.014	100	123		
53925		12.70	2.00	8.70	0.182	100	100									
42737		12.70	2.65	7.40	0.225	100	100	42499	30.00	1.20	27.60	0.294	100	138		
42823		12.70	3.20	6.30	0.259	100	100	53734	30.00	2.00	26.00	0.475	100	135		
57432		13.70	3.10	7.50	0.279	100	100	13193	30.00	5.30	19.40	1.118	100	125		
55548		14.00	3.60	6.80	0.319	100	100	58344	30.00	6.25	17.50	1.265	122	100		
53001		14.30	2.50	9.30	0.251	100	100	58503	30.00	8.00	14.00	1.500	100	116		
50628		15.00	1.50	12.00	0.172	100	100	52207	31.20	2.80	25.60	0.677	100	138		
10631		15.80	1.20	13.40	0.149	100	100	42686	31.80	1.60	28.60	0.412	100	145		
50142		15.80	2.00	11.80	0.236	100	100	42687	31.80	3.20	25.40	0.780	100	140		
42724		15.90	1.60	12.70	0.195	100	100	58816	32.00	2.00	28.00	0.511	101	145		
53676		16.00	1.20	13.60	0.150	100	100	58364	32.00	3.00	26.00	0.741	142	101		
42511		16.00	1.50	13.00	0.185	100	100	42498	33.00	1.20	30.60	0.325	104	152		
56118		16.00	4.00	8.00	0.408	100	100	50949	33.00	5.00	23.00	1.192	104	140		
11325		16.50	2.80	10.90	0.327	100	100	53112	33.00	5.50	22.00	1.289	104	138		
13190		16.50	3.70	9.10	0.401	100	100	42345	33.00	6.30	20.50	1.450	104	136		
56295		18.50	4.30	9.90	0.520	100	100	13338	34.50	7.60	19.30	1.742	108	139		
42678		19.00	1.20	16.60	0.182	100	100	55145	35.00	1.70	31.60	0.482	110	160		
55802	19.00	1.50	16.00	0.223	100	100	57089	35.00	2.00	31.00	0.562	110	159			
50540	19.00	1.60	15.80	0.237	100	100	54940	35.00	2.50	30.00	0.692	110	157			
53659	19.00	2.00	15.00	0.289	100	100	50162	35.00	4.70	25.60	1.213	110	150			
11326	19.00	3.20	12.60	0.430	100	100	50613	37.50	1.20	35.10	0.371	118	173			
42739	19.30	3.20	12.90	0.439	100	100	50270	38.00	1.20	35.60	0.376	119	175			
								55387	38.00	1.50	35.00	0.467	119	174		
56669	>20mm	20.00	4.50	11.00	0.549	100	100	10635	38.00	1.60	34.80	0.496	120	174		
53613		20.00	4.80	10.40	0.621	100	100	42689	38.00	2.00	34.00	0.602	119	166		
50254		20.00	6.25	7.50	0.732	100	100	50619	38.00	3.00	32.00	0.895	119	169		
11327		21.30	3.60	14.10	0.542	100	100	42691	38.00	3.20	31.60	0.948	119	169		
50146		21.40	1.40	18.60	0.238	100	100	42346	38.00	7.50	23.00	1.949	119	155		
13097		21.70	2.20	17.30	0.366	100	100	56245	38.00	8.20	21.60	2.082	120	153		
42355		21.80	1.40	19.00	0.243	100	100									
50114		22.00	1.20	19.60	0.213	100	100	54933	40.00	1.50	37.00	0.492	126	184		
50148		22.00	1.40	19.20	0.246	100	100	56236	40.00	3.00	34.00	0.945	126	180		
11683		22.20	1.60	19.00	0.281	100	100	58116	40.00	5.00	30.00	1.491	126	173		
42681		22.25	1.20	19.85	0.215	100	100	57076	40.00	8.50	23.00	2.281	126	162		
53649		22.25	2.80	16.65	0.464	100	100	42749	41.30	4.70	31.90	1.466	130	180		
50013		23.00	4.80	13.40	0.744	100	100	13340	42.50	7.25	28.00	2.178	134	100		
									42347	43.00	7.30	28.40	2.221	135	179	
11328		>40mm	23.80	4.00	15.80	0.675	100	100	42692	44.50	3.20	38.10	1.126	140	200	
53890			24.70	1.40	21.90	0.277	100	112	11444	45.00	2.50	40.00	0.905	134	197	
53885			25.00	2.00	21.00	0.392	100	112	13283	46.50	10.80	24.90	3.285	146	185	
55768			25.00	1.80	21.40	0.356	100	113	54342	47.00	1.20	44.60	0.468	147	217	
50154			25.00	1.60	21.80	0.319	100	113	58732	47.00	1.60	43.80	0.619	148	217	
50153			25.00	1.40	22.20	0.281	100	114	56351	47.50	1.40	44.70	0.549	149	219	
50115			25.00	1.20	22.60	0.245	100	114	42302	48.00	8.50	31.00	2.860	151	200	
54368			25.00	1.15	22.70	0.233	100	114	54748	48.00	3.00	42.00	1.150	151	217	
50541			25.00	3.00	19.00	0.562	100	109	42752	48.50	4.50	39.50	1.687	152	214	
52782			25.50	1.20	23.10	0.248	100	117								
42684			25.50	1.25	23.00	0.258	100	116								
54265	25.50		1.50	22.50	0.306	100	115									
42685	25.50		1.60	22.30	0.326	100	115									
42725	25.50		2.00	21.50	0.400	100	114									
42714	25.50		3.20	19.10	0.602	100	110									

TUBING
 Square 2
 Rectangular 3
 Round 4-5

ANGLES
 Equal Leg 6
 Unequal Leg 7

CHANNELS
 Equal Leg 8-9
 Lipped & Top Hat 10

MISC
 T & H Sections 11

BARS
 Flat Bar 12
 Hexagon Bar 13
 Square Bar 13
 Round Bar 13

Material Specifications

All material will be Aluminium 6063-T6 unless specified or requested. All lengths can be supplied in 6m lengths. Longer lengths can be supplied on special request.

Surface Finish

All lengths are available in mill finish, powder coated or anodized.

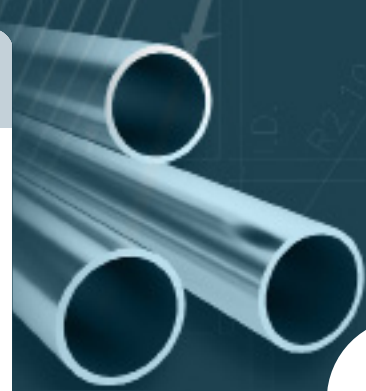

HOLLOW

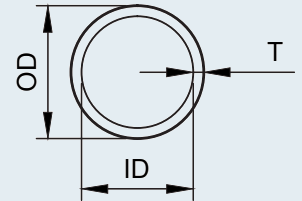

SECTION NO.	RANGE	OD	T	ID	Kg/m	PAINT PERMETER	ANODIZED PERMETER
11167	> 50mm	50.00	1.50	47.00	0.619	157	231
50749		50.00	1.80	46.40	0.739	157	230
42330		50.00	1.90	46.20	0.779	157	230
54932		50.00	2.00	46.00	0.818	157	229
42331		50.00	2.20	45.60	0.896	157	229
53887		50.00	5.00	40.00	1.917	157	220
42965		50.60	1.50	47.60	0.627	159	234
54948		50.60	1.90	46.80	0.788	159	232
50173		50.00	3.00	44.00	1.201	160	231
50174		50.80	5.00	40.80	1.951	160	224
50170		51.00	1.20	48.60	0.509	160	237
42693		51.00	1.30	48.40	0.551	160	236
50172		51.00	1.60	47.80	0.673	160	235
50120		51.00	1.90	47.20	0.795	160	234
42694		51.00	2.00	47.00	0.835	160	234
10629		51.00	3.20	44.60	1.303	160	230
11443		55.00	2.50	50.00	1.118	165	244
13339		58.00	8.50	41.00	3.585	182	246
54870		58.00	12.00	34.00	4.703	182	236
56307		59.00	9.50	40.00	4.006	185	248
42316	59.00	10.50	38.00	4.339	185	245	
54600	> 60mm	60.00	1.60	56.80	0.796	188	272
42514		60.30	3.20	53.90	1.557	189	274
56280		60.30	4.00	52.30	1.919	189	272
42594		63.50	2.00	59.50	1.048	199	293
42697		63.50	3.20	57.10	1.644	199	289
56308	66.00	11.00	44.00	5.155	207	276	
42647	> 70mm	70.00	1.30	67.40	0.761	220	326
57088		70.00	5.00	60.00	2.770	220	314
56281		72.00	5.20	61.60	2.960	226	323
42327		72.00	6.00	60.00	3.374	226	320
57111		73.00	5.20	60.60	3.004	229	328
42698		76.20	1.30	73.60	0.830	239	354
42855		76.20	1.60	73.00	1.017	240	355
56077		76.20	2.00	72.20	1.125	239	353
42699		76.20	3.20	69.80	1.990	239	349
58104		76.20	6.35	63.50	3.779	239	339
42336	76.30	3.00	70.30	1.874	240	351	
57401	76.50	1.25	74.00	0.801	240	356	
56282	79.40	3.40	72.60	2.202	249	363	
56321	> 80mm	80.00	2.00	76.00	1.329	251	371
52210		80.00	4.00	72.00	2.590	252	366
56106		80.00	5.00	70.00	3.195	252	361
52265		80.00	6.00	68.00	3.783	252	389
11936		80.00	8.00	64.00	4.908	252	303
56306		85.00	19.50	46.00	10.883	267	340
11441		87.00	3.50	80.00	2.478	274	400
56283		87.60	3.50	80.60	2.508	275	402
56739		89.00	3.20	82.60	2.340	280	410
54896		89.00	4.80	79.40	3.443	280	405
11969	> 100mm	100.00	4.00	92.00	3.272	315	466
52353		100.00	6.00	88.00	4.805	314	452
53497		100.00	8.00	84.00	6.243	314	446
56995		100.00	10.00	80.00	7.668	314	439
42731		100.50	4.80	90.90	3.914	316	459
42756		101.00	3.20	94.60	2.666	317	466
11808		101.50	3.20	95.10	2.680	299	468
42854		101.60	1.60	98.40	1.363	319	474
56464		101.60	3.60	94.40	3.006	319	468
42795		104.50	3.30	97.90	2.845	328	482
11440	108.00	4.00	100.00	3.528	340	498	
56237	> 110mm	114.00	4.00	106.00	3.749	358	525
56051		114.00	5.00	104.00	4.643	358	522
11590		114.30	6.00	102.30	5.537	360	520
54050		117.00	2.00	113.00	1.960	368	546
11970	> 120mm	120.00	4.00	112.00	3.953	377	553
11968		120.00	6.00	108.00	5.828	377	547
53495		120.00	8.00	104.00	7.600	377	540
42715		127.00	3.50	120.00	3.684	400	589
56244		140.00	5.00	130.00	5.751	440	644
56067		150.00	6.00	138.00	7.362	471	688
56828		150.00	8.00	134.00	9.679	471	681
56249		157.00	3.00	151.00	3.937	493	730
55908		160.00	6.00	148.00	7.873	503	736
57259		160.00	7.00	146.00	9.126	503	732
58040	160.00	8.00	144.00	10.361	503	729	

Material Specifications

All material will be Aluminium 6063-T6 unless specified or requested. All lengths can be supplied in 6m lengths. Longer lengths can be supplied on special request.

Surface Finish

All lengths are available in mill finish, powder coated or anodised.

TUBING

- Square 2
- Rectangular..... 3
- Round..... 4-5

ANGLES

- Equal Leg..... 6
- Unequal Leg..... 7

CHANNELS

- Equal Leg 8-9
- Lipped & Top Hat 10

MISC

- T & H Sections..... 11

BARS

- Flat Bar 12
- Hexagon Bar 13
- Square Bar 13
- Round Bar..... 13



SOLIDS

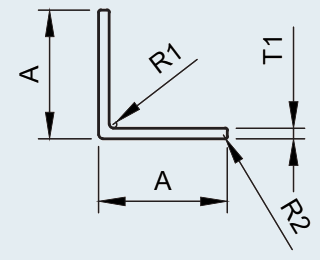

SECTION NO.	RANGE	A	T1	R1	R2	Kg/m	PAINT / ANODIZED PERMETER
11193	> 10mm	12.00	1.50	0.30	0.30	0.092	100
11166		12.00	3.00	0.30	0.30	0.171	100
28241		12.50	1.50	0.30	0.30	0.094	100
02689		12.70	1.60	0.30	0.30	0.103	100
00454		12.70	3.20	0.30	0.30	0.192	100
70143		15.00	1.50	0.30	0.30	0.116	100
27891		15.00	1.60	0.30	0.30	0.122	100
00163		15.90	3.20	0.30	0.30	0.248	100
21081		16.00	1.50	0.30	0.30	0.124	100
10386		19.00	1.60	0.30	0.30	0.157	100
31921		19.00	2.00	0.30	0.30	0.195	100
10588		19.00	3.20	0.30	0.30	0.301	100
11303	> 20mm	22.20	1.60	0.30	0.30	0.185	100
70150		25.00	1.20	0.30	0.30	0.159	100
11356		25.00	1.30	0.30	FULL	0.170	100
34302		25.00	1.50	0.30	0.30	0.197	100
10968		25.00	1.60	0.30	0.30	0.209	100
31922		25.00	2.00	0.30	0.30	0.260	100
70162		25.00	3.00	0.30	0.30	0.382	100
22326		25.50	1.20	0.30	FULL	0.160	100
10387		25.50	1.60	0.30	0.30	0.213	101
18356		25.50	2.50	0.65	0.30	0.328	101
52079		25.50	3.20	0.30	0.30	0.413	101
19010		25.50	4.80	0.30	0.30	0.598	101
00252	25.50	6.40	0.30	0.30	0.770	101	
70298	> 30mm	30.00	3.00	0.30	0.30	0.464	120
28540		31.80	1.60	0.30	0.30	0.268	126
03436		31.80	3.20	0.30	0.30	0.524	126
52081		31.80	4.80	0.30	0.30	0.765	126
52082		31.80	6.40	0.30	0.30	0.992	126
70152		32.00	3.00	0.30	0.30	0.496	127
19322		38.00	1.20	0.30	0.30	0.243	152
30674		38.00	1.60	0.30	0.30	0.323	152
28959		38.00	1.80	0.30	0.30	0.362	151
10967		38.00	2.00	0.30	0.30	0.401	152
70156		38.00	3.00	0.30	0.30	0.594	151
52077		38.00	3.20	0.30	0.30	0.633	152
52075	38.00	4.80	0.30	0.30	0.929	152	
52080	38.00	6.40	0.30	0.30	1.211	152	
33099	> 40mm	40.00	3.00	0.30	0.30	0.626	159
18301		44.50	3.20	0.30	0.30	0.744	177
30675	> 50mm	50.00	1.60	0.30	0.30	0.427	200
20423		50.00	2.00	0.30	0.30	0.531	204
28464		50.00	3.00	0.30	0.30	0.789	199
11350		50.00	6.00	0.30	0.30	1.528	200
19262		50.50	3.00	0.30	0.30	0.797	202
52072		51.00	3.20	0.30	0.30	0.857	203
52073		51.00	4.80	0.30	0.30	1.265	203
52078		51.00	6.40	0.30	0.30	1.659	203
11850	> 60mm	63.00	6.00	0.30	0.30	1.952	252
18422		63.50	3.20	0.30	0.30	1.074	253
00423		63.50	6.40	0.50	0.50	2.092	253
22114		65.00	2.00	0.30	0.30	0.694	260
11163	> 70mm	75.00	3.00	0.30	0.30	1.196	300
29351		76.00	2.00	0.30	0.30	0.813	303
18997		76.00	3.00	0.30	0.30	1.212	303
32945		76.00	4.00	0.30	0.30	1.605	303
52084		76.00	6.40	0.30	0.30	2.527	303
34472	> 100mm	100.00	3.00	0.30	0.30	1.602	399
33290		101.60	10.00	0.30	2.50	5.222	401

Material Specifications

All material will be Aluminium 6063-T6 unless specified or requested. All lengths can be supplied in 6m lengths. Longer lengths can be supplied on special request.

Surface Finish

All lengths are available in mill finish, powder coated or anodised.

TUBING

- Square 2
- Rectangular 3
- Round 4-5

ANGLES

- Equal Leg 6
- Unequal Leg 7

CHANNELS

- Equal Leg 8-9
- Lipped & Top Hat 10

MISC

- T & H Sections 11

BARS

- Flat Bar 12
- Hexagon Bar 13
- Square Bar 13
- Round Bar 13

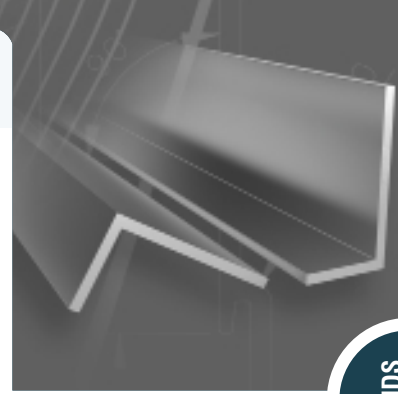

SOLIDS

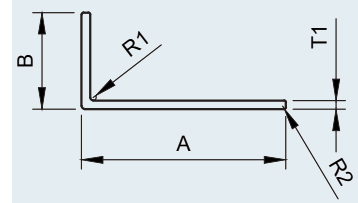

SECTION NO.	RANGE	A	B	T1	R1	R2	Kg/m	PAINT / ANODIZED PER METER
70140	> 10mm	12.50	9.00	1.50	0.30	0.30	0.081	100
18201		12.70	9.50	1.60	0.50	0.50	0.089	100
25023		15.00	14.00	1.20	0.30	0.30	0.084	100
01295		16.00	9.50	1.60	0.30	0.30	0.103	100
19183		17.50	10.00	1.50	0.30	0.30	0.106	100
18228	> 20mm	21.00	6.50	1.60	0.30	0.79	0.110	100
18287		22.00	8.00	3.20	0.60	0.60	0.232	100
00505		22.00	9.50	1.60	0.30	0.30	0.130	100
18879		22.00	9.50	3.20	0.30	0.30	0.245	100
11164		25.00	12.00	3.00	0.30	0.30	0.276	100
20699		25.00	12.50	1.50	0.30	0.30	0.146	100
70295		25.00	20.00	3.00	0.30	0.30	0.342	100
00294		25.50	12.50	3.20	0.30	0.30	0.301	100
18345		25.50	14.50	1.60	0.30	0.30	0.166	100
52174		> 30mm	30.00	20.00	2.50	0.30	0.30	0.322
52727	31.20		10.00	1.20	1.00	0.60	0.129	100
02961	32.00		19.00	3.20	0.30	0.30	0.414	101
18664	32.00		25.00	3.20	0.30	0.30	0.466	113
10292	36.00		28.00	2.00	0.30	0.30	0.336	128
20393	36.50		28.50	2.00	0.30	0.30	0.341	129
19319	38.00		13.00	3.20	0.30	0.30	0.414	101
18132	38.00		19.00	3.20	0.30	0.30	0.466	113
10787	38.00		25.00	1.60	0.30	0.30	0.266	126
19477	38.00		25.50	3.20	0.30	0.30	0.523	126
33953	> 40mm	40.00	30.00	2.00	0.30	0.30	0.369	139
70157		44.00	22.00	2.00	0.30	0.30	0.347	131
11953		44.00	22.00	3.00	0.30	0.30	0.512	132
01405		44.50	22.00	2.00	0.30	0.30	0.350	132
00069		44.50	22.00	3.20	0.30	0.30	0.549	132
11165	> 50mm	50.00	25.00	1.50	0.30	0.30	0.299	150
70163		50.00	25.00	1.60	0.30	0.30	0.318	149
70158		50.00	25.00	3.00	0.30	0.30	0.586	149
18015		51.00	25.50	1.30	0.30	0.30	0.265	152
00819		51.00	25.50	1.50	0.30	0.30	0.304	152
19273		51.00	25.50	1.60	0.30	0.30	0.324	152
10394		51.00	25.50	3.20	0.30	0.30	0.636	152
22025		60mm - 80mm	63.50	19.00	2.50	0.30	0.30	0.542
34036	65.00		45.00	3.00	0.30	0.30	0.876	218
11956	75.00		25.00	2.00	0.30	0.30	0.531	200
19428	76.00		18.00	1.50	0.30	0.30	0.376	187
70304	76.00		22.00	2.00	0.30	0.30	0.521	195
20186	76.00		25.00	2.00	0.30	0.30	0.538	202
33912	76.00		38.00	2.00	0.30	0.30	0.607	227
70167	76.00		38.00	3.00	0.30	0.30	0.903	227
19119	76.00		38.00	3.20	0.30	0.30	0.961	227
20402	76.00		38.00	4.80	0.30	0.30	1.421	227
30506	76.00		51.00	4.80	0.30	0.30	1.590	253
29423	76.00		51.00	6.50	0.30	0.30	2.120	253
52570	> 80mm		80.00	40.00	1.60	0.30	0.30	0.513
28206		80.00	50.00	5.00	0.30	0.30	1.692	258
18133		86.00	38.00	2.50	0.30	0.30	0.823	247
18316		89.00	63.50	6.50	0.30	0.30	2.573	304
20417	100mm	100.00	22.00	1.60	0.30	0.30	0.504	242
35394		100.00	40.00	3.00	0.30	0.30	1.114	279
11960		100.00	40.00	4.00	0.30	0.30	1.484	280
34473		100.00	50.00	3.00	0.30	0.30	1.196	299
32923		100.00	50.00	6.00	0.30	0.30	2.343	299
33853		115.00	39.00	5.00	2.50	0.30	2.024	306
20780	> 120mm	120.00	40.00	2.00	0.30	0.30	0.857	320
11409		125.00	50.00	8.00	0.30	0.30	3.623	350
30778		127.00	50.00	2.00	0.30	0.30	0.949	353
36177		135.00	70.00	3.00	0.30	0.30	1.644	410
32924	150mm	150.00	50.00	6.00	0.30	0.30	3.156	399
29236		152.00	76.00	9.50	0.30	0.30	5.629	451

TUBING

- Square 2
- Rectangular 3
- Round 4-5

ANGLES

- Equal Leg 6
- Unequal Leg 7

CHANNELS

- Equal Leg 8-9
- Lipped & Top Hat 10

MISC

- T & H Sections 11

BARS

- Flat Bar 12
- Hexagon Bar 13
- Square Bar 13
- Round Bar 13

Material Specifications

All material will be Aluminium 6063-T6 unless specified or requested. All lengths can be supplied in 6m lengths. Longer lengths can be supplied on special request.

Surface Finish

All lengths are available in mill finish, powder coated or anodised.

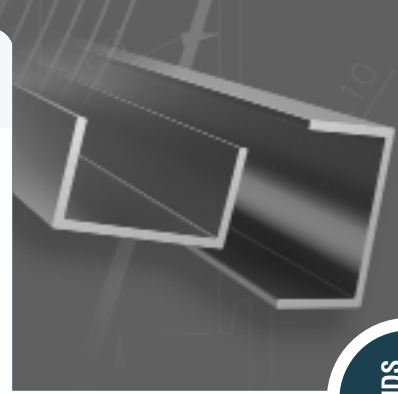

SOLIDS

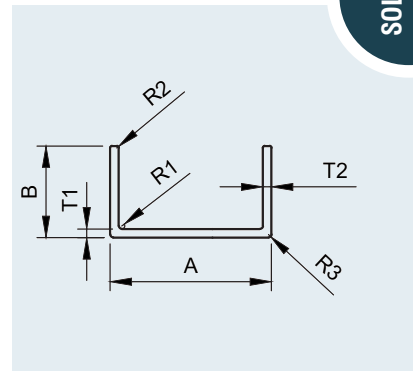

SECTION NO.	RANGE	A	B	T1	T2	R1	R2	R3	Kg/m	PAINT / ANODIZED PER METER
70169	< 10mm	9.00	9.00	1.60	1.60	0.30	0.30	0.30	0.103	100
00478		9.50	9.52	1.60	1.60	0.30	0.30	0.30	0.110	100
21392		9.50	12.70	1.60	1.60	0.30	0.30	0.30	0.137	100
70310	10mm - 20mm	12.00	12.00	1.50	1.50	0.30	0.30	0.30	0.134	100
00184		12.70	9.50	1.50	1.50	0.30	0.30	0.30	0.116	100
10444		12.70	12.70	2.00	2.02	0.30	0.30	0.30	0.188	100
10912		13.00	9.50	1.50	1.50	0.30	0.30	0.30	0.117	100
28126		14.00	16.50	1.75	1.75	0.30	0.30	0.30	0.205	100
20042		15.90	15.90	1.70	1.70	0.30	0.30	0.30	0.204	100
28604		16.00	16.00	1.20	1.20	0.64	0.64	0.60	0.147	100
70329		17.00	15.00	1.20	1.20	0.30	0.30	0.30	0.145	100
19192		19.00	9.50	1.50	1.50	0.30	0.30	0.30	0.142	100
02948		19.00	12.70	1.60	1.60	0.30	0.30	0.30	0.178	100
22881		19.00	21.00	1.20	1.20	0.50	0.50	FULL	0.191	118
11293	19.20	19.20	1.20	1.20	0.30	0.30	0.30	0.179	113	
10642	19.50	19.50	1.30	1.30	0.30	0.30	0.30	0.197	113	
34229	> 20mm	20.00	14.50	1.60	1.60	0.30	0.30	0.30	0.198	100
18461		20.60	19.80	2.00	2.00	0.30	0.30	0.30	0.304	115
21296		21.00	21.00	1.20	1.20	0.30	0.30	FULL	0.197	123
26152		21.00	25.00	2.00	2.00	0.30	0.30	0.30	0.362	132
35993		21.00	50.00	2.00	2.00	0.30	0.30	0.30	0.634	237
70171		21.40	21.00	1.20	1.20	0.30	0.30	0.30	0.198	123
20869		22.00	22.00	2.00	2.00	0.30	0.30	0.30	0.336	128
29363		22.20	14.00	1.20	1.20	0.50	FULL	1.50	0.152	100
32021		22.60	15.50	1.50	1.50	0.30	0.30	0.30	0.205	103
18654		23.00	23.00	1.30	1.30	0.30	0.30	0.30	0.243	134
11368		25.00	12.00	3.00	3.00	0.30	0.30	0.30	0.349	100
30360		25.00	20.00	3.50	3.50	0.30	0.30	0.30	0.550	122
19216		25.50	12.70	1.50	1.50	0.30	0.30	0.30	0.195	100
00945		25.50	12.70	3.20	3.20	0.30	0.30	0.30	0.386	100
19064		25.50	22.20	3.20	1.60	0.60	0.60	FULL	0.384	131
52076		25.50	25.50	3.20	3.20	0.30	0.30	0.30	0.608	146
34105		26.00	21.50	1.50	1.50	0.30	0.30	0.30	0.268	134
10308		27.30	25.00	3.00	3.00	0.30	0.30	0.30	0.580	148
20556		28.00	79.00	2.50	2.50	0.30	0.30	0.30	1.227	366
20018		28.50	16.00	1.50	1.50	0.30	0.30	0.30	0.234	117
34138	> 30mm	30.00	30.00	3.00	3.00	0.30	0.30	0.30	0.683	173
37231		31.60	24.00	1.30	1.30	0.80	2.40	0.30	0.264	153
18399		31.80	12.50	2.50	2.50	0.30	0.30	0.30	0.351	108
70428		32.00	23.00	1.20	1.20	0.30	1.20	0.30	0.244	153
70429		35.00	25.00	1.40	1.40	0.30	1.40	0.30	0.310	166
28193		35.00	63.00	1.90	1.90	0.30	0.30	0.30	0.810	317
30184		36.00	27.50	2.20	2.20	0.30	0.30	0.30	0.516	177
33157		37.20	19.00	1.60	1.60	0.30	0.30	0.30	0.312	146
00032		38.00	19.00	3.20	3.20	0.30	0.30	0.30	0.604	145
28213		38.00	20.00	1.40	1.40	0.30	0.30	0.30	0.285	152
19153	38.00	38.00	3.20	3.20	0.30	0.30	0.30	0.934	221	
36867	> 40mm	40.00	15.00	2.00	2.00	0.30	0.30	0.30	0.358	135
26446		43.00	18.00	2.20	1.20	1.60	3.20	0.30	0.350	149
70318		43.50	25.00	1.70	1.70	0.30	0.30	0.30	0.415	183
30401		44.00	17.00	2.00	2.00	0.30	0.30	0.30	0.401	151
32560		44.00	28.00	1.80	1.80	0.30	0.30	0.30	0.470	196
32949		44.00	31.50	1.50	1.50	0.30	0.30	0.30	0.422	210
23224		44.40	19.00	1.60	1.60	0.30	0.60	0.80	0.341	159
72276		46.00	30.00	3.00	3.00	cham	cham	cham	0.779	198
34361		46.50	29.50	2.00	2.00	0.30	0.30	FULL	0.548	205
18446		47.50	19.00	1.50	1.50	0.30	0.30	0.30	0.335	166
37420	> 50mm	50.00	25.00	1.50	1.50	0.30	0.30	0.30	0.394	196
37419		50.00	25.00	2.00	2.00	0.30	0.30	0.30	0.520	195
52343		50.00	25.00	3.00	3.00	0.30	0.30	0.30	0.764	193
33208		50.50	20.00	1.50	1.50	0.30	0.30	0.30	0.355	177
00747		51.00	25.40	3.20	3.20	0.30	0.30	0.30	0.828	196
11562		54.50	30.00	2.00	2.00	0.30	0.30	0.30	0.599	225
18658		57.20	32.00	3.20	3.20	0.30	0.30	0.30	0.996	235

TUBING
 Square 2
 Rectangular 3
 Round 4-5

ANGLES
 Equal Leg 6
 Unequal Leg 7

CHANNELS
 Equal Leg 8-9
 Lipped & Top Hat 10

MISC
 T & H Sections 11

BARS
 Flat Bar 12
 Hexagon Bar 13
 Square Bar 13
 Round Bar 13

Material Specifications

All material will be Aluminium 6063-T6 unless specified or requested. All lengths can be supplied in 6m lengths. Longer lengths can be supplied on special request.

Surface Finish

All lengths are available in mill finish, powder coated or anodized.

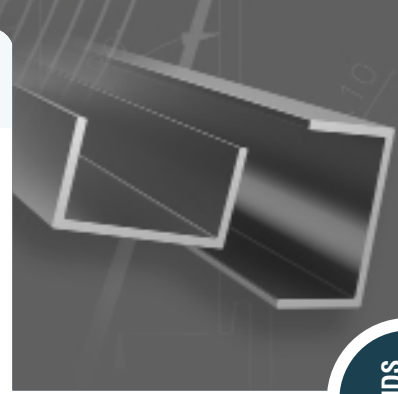

SOLIDS

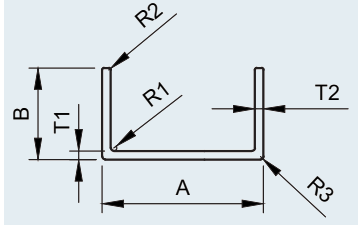

SECTION NO.	RANGE	A	B	T1	T2	R1	R2	R3	Kg/m	PAINT / ANODIZED PERIMETER
34052	> 60mm	60.00	25.00	1.20	1.20	0.30	0.30	0.30	0.350	217
11430		60.00	30.00	1.70	1.70	0.30	0.30	0.30	0.537	237
70323		63.50	32.00	3.00	3.00	0.30	0.30	0.30	0.988	248
52571		64.00	12.00	2.00	2.00	0.30	0.30	0.30	0.455	172
32782	> 70mm	76.00	14.00	1.60	1.60	0.30	0.30	0.30	0.437	204
01835		76.00	38.00	3.00	3.00	2.00	0.30	0.30	1.188	295
0009A		76.00	38.00	6.40	8.00	7.62	0.30	0.30	2.758	284
33547		76.20	20.00	1.70	1.70	0.30	0.50	0.85	0.479	227
34578	> 70mm	78.60	28.00	1.30	1.30	0.30	0.30	0.30	0.465	266
29118	> 80mm	80.00	35.00	2.00	2.00	0.30	0.30	0.30	0.791	294
22209		80.50	21.00	1.50	1.50	0.30	0.30	0.30	0.486	242
23732		82.50	38.00	2.40	2.40	0.30	0.30	0.30	1.000	311
18726		82.50	38.00	3.00	3.00	0.30	0.30	0.30	1.241	310
11903		84.50	35.00	1.80	1.80	0.30	0.30	0.30	0.736	304
18400	> 80mm	92.50	40.00	2.00	2.00	0.30	0.30	0.30	0.914	340
34070	> 100mm	101.00	50.00	3.00	3.00	0.30	0.30	0.30	1.586	395
52363		101.50	25.50	3.20	3.20	0.30	0.30	0.30	1.216	298
0009C		101.50	51.00	6.40	8.00	9.00	0.30	0.30	3.791	386
33815		104.00	42.00	2.00	2.00	0.30	0.30	0.30	0.998	371
21761		105.00	38.00	1.50	1.50	0.30	0.30	FULL	0.724	359
52533		105.50	54.00	6.00	6.00	0.30	0.30	0.30	3.278	414
33241		114.00	35.00	10.00	10.00	0.30	2.50	2.50	4.426	341
33058	> 150mm	120.00	45.00	10.00	10.00	0.30	0.30	0.30	5.153	399
32832		127.00	50.00	4.80	4.80	0.30	0.30	0.30	2.830	443
32080		150.00	50.00	2.00	2.00	0.30	0.30	0.30	1.334	495
33248		152.40	76.20	10.00	10.00	5.00	2.50	2.50	7.732	579
22810		152.40	76.20	9.50	12.70	2.00	0.30	0.30	8.523	590
26089		152.70	54.00	10.50	10.50	10.00	1.00	1.00	6.939	490

TUBING

- Square 2
- Rectangular 3
- Round 4-5

ANGLES

- Equal Leg 6
- Unequal Leg 7

CHANNELS

- Equal Leg 8-9
- Lipped & Top Hat 10

MISC

- T & H Sections 11

BARS

- Flat Bar 12
- Hexagon Bar 13
- Square Bar 13
- Round Bar 13

Material Specifications

All material will be Aluminium 6063-T6 unless specified or requested. All lengths can be supplied in 6m lengths. Longer lengths can be supplied on special request.

Surface Finish

All lengths are available in mill finish, powder coated or anodised.



SOLIDS

LIPPED CHANNEL

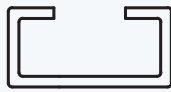

SECTION NO.	RANGE	A	B	C	D	T1	T2	T3	R1	R2	Kg/m	PAINT / ANODIZED PERIMETER
19921	20mm-50mm	18.40	5.90	11.00	3.70	1.20	1.20	1.20	0.30	1.00	0.107	100
31064		30.00	9.00	12.00	9.00	2.00	2.00	2.00	0.30	0.30	0.314	118
14052		35.00	15.00	15.00	10.00	2.50	2.50	2.50	0.30	0.30	0.508	155
19835		41.32	4.76	33.34	3.99	1.62	1.62	2.40	0.30	0.30	0.236	105
20512		50.00	3.94	44.00	3.00	1.20	1.14	1.50	0.75	0.75	0.186	117
70722		50.00	30.00	20.00	15.00	5.00	5.00	5.00	0.30	0.30	1.627	248

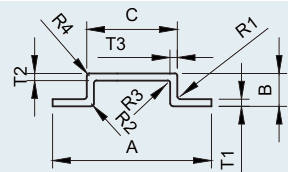
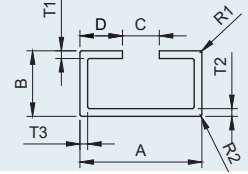

TOP HAT PROFILES



SECTION NO.	RANGE	A	B	C	T1	T2	T3	R1	R2	R3	Kg/m	PAINT / ANODIZED PERIMETER
21426		57.20	28.50	23.80	2.20	2.20	2.50	0.30	2.50	0.30	0.669	218
32137		75.00	19.00	47.60	2.00	2.00	0.30	0.30	0.30	0.30	0.591	220

TUBING

- Square 2
- Rectangular 3
- Round 4-5

ANGLES

- Equal Leg 6
- Unequal Leg 7

CHANNELS

- Equal Leg 8-9
- Lipped & Top Hat 10

MISC

- T & H Sections 11

BARS

- Flat Bar 12
- Hexagon Bar 13
- Square Bar 13
- Round Bar 13

Material Specifications

All material will be Aluminium 6063-T6 unless specified or requested. All lengths can be supplied in 6m lengths. Longer lengths can be supplied on special request.

Surface Finish

All lengths are available in mill finish, powder coated or anodized.

T-SECTIONS

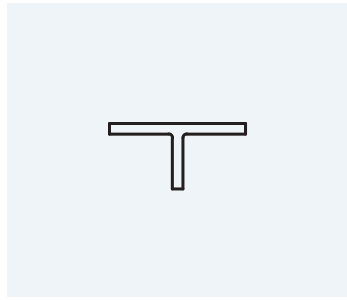

SECTION NO.	RANGE	A	B	T1	T2	R	Kg/m	PAINT / ANODIZED PERIMETER
35172	10mm	8.00	13.50	1.20	1.20	0.30	0.065	100
19461		9.50	20.00	1.50	1.50	0.30	0.111	100
22651		19.00	19.00	3.00	3.00	0.30	0.285	100
32846	>20mm	20.00	33.50	1.50	2.00	0.30	0.254	106
36384		22.00	42.00	1.90	1.90	0.30	0.320	127
25022		22.00	42.00	2.00	2.00	0.30	0.335	128
70376		22.00	45.00	2.00	2.00	0.30	0.352	133
22324		25.00	25.00	1.60	1.60	0.30	0.209	100
02169		25.50	25.50	3.20	3.20	0.30	0.415	101
31095	>30mm	30.00	20.00	2.00	2.00	0.30	0.260	100
28974		38.00	12.70	1.20	1.20	0.30	0.160	100
10963		38.00	38.00	1.26	1.26	0.30	0.255	152
71646		38.00	38.00	2.00	2.00	0.30	0.403	152
20598		38.00	38.00	3.00	3.00	0.30	0.593	151
23085		38.00	38.00	4.80	4.48	5.84	0.965	146
34582	>40mm	40.00	20.00	1.50	1.50	0.30	0.237	119
36593		50.00	25.00	2.00	2.00	1.00	0.393	147
70377		50.00	50.00	3.00	3.00	0.30	0.789	199
33705		98.50	50.80	3.20	3.20	0.30	1.267	296
72275		120.00	50.00	3.00	2.50	6.00	1.228	334

H-SECTIONS

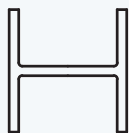

SECTION NO.	RANGE	A	B	T1	T2	R1	Kg/m	PAINT / ANODIZED PERIMETER
11775	<20mm	15.50	6.50	1.20	1.20	0.30	0.085	100
32134		16.00	16.00	1.60	1.60	0.30	0.192	100
22879		19.00	21.00	1.20	1.20	0.50	0.191	120
11290		19.20	20.00	1.20	1.20	0.30	0.185	116
21297	>20mm	21.00	21.00	1.20	1.20	0.30	0.196	121
10643		48.50	27.50	2.00	2.00	0.30	0.540	201
18994		63.50	44.50	3.00	3.00	3.00	1.000	293

Material Specifications

All material will be Aluminium 6063-T6 unless specified or requested. All lengths can be supplied in 6m lengths. Longer lengths can be supplied on special request.

Surface Finish

All lengths are available in mill finish, powder coated or anodized.



SOLIDS

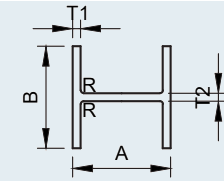
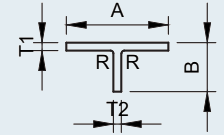

TUBING

- Square 2
- Rectangular 3
- Round 4-5

ANGLES

- Equal Leg 6
- Unequal Leg 7

CHANNELS

- Equal Leg 8-9
- Lipped & Top Hat 10

MISC

- T & H Sections 11

BARS

- Flat Bar 12
- Hexagon Bar 13
- Square Bar 13
- Round Bar 13

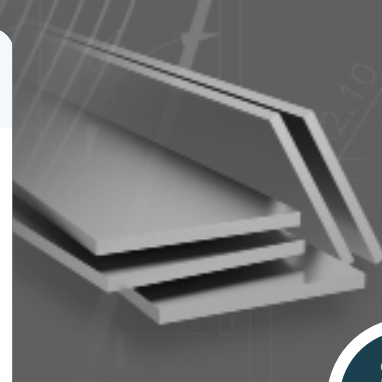

SOLIDS

SECTION NO.	RANGE	A	B	R1	Kg/m	PAINT / ANODIZED PERIMETER	SECTION NO.	RANGE	A	B	R1	Kg/m	PAINT / ANODIZED PERIMETER	
30052		7.60	6.80	1.00	0.137	100	70355		50.00	2.00	0.30	0.271	103	
19145	> 10mm	10.00	4.00	0.30	0.108	100	11171	> 50mm	50.00	3.00	0.30	0.407	106	
30825		12.00	2.00	0.30	0.065	100	32598		50.00	4.20	0.30	0.569	107	
70254		12.00	3.00	0.30	0.097	100	20861		50.00	6.00	0.20	0.804	112	
20822		12.40	3.00	0.30	0.101	100	32297		50.00	16.00	0.30	2.169	131	
18023		12.70	3.20	FULL	0.104	100	52394		50.00	25.80	0.30	3.498	152	
10742		12.70	3.20	0.30	0.110	100	18501		50.80	2.00	0.30	0.274	105	
19577		12.70	4.80	0.30	0.165	100	52074		51.00	3.20	0.30	0.437	108	
10569		15.90	3.20	0.30	0.138	100	11299		51.00	4.80	0.30	0.661	112	
22811		16.00	1.60	0.50	0.069	100	52071		51.00	6.40	0.30	0.885	114	
21197		16.00	3.00	0.30	0.130	100	33291		51.00	6.40	2.00	0.866	111	
36439		16.00	3.00	FULL	0.125	100	0250Y		51.00	9.50	0.30	1.314	120	
22812		18.00	1.60	0.30	0.078	100	0250B		51.00	12.70	0.30	1.757	127	
31919		19.00	2.00	0.30	0.102	100	18948		51.00	25.50	0.30	3.527	152	
18450		19.00	2.40	0.30	0.123	100								
19342		19.00	3.00	0.30	0.155	100	11411		> 60mm	60.00	10.00	FULL	1.569	131
11732	19.00	3.20	0.30	0.165	100	34656	62.00	21.00		5.00	3.473	158		
0034H	19.00	4.80	0.30	0.247	100	18656	63.50	3.20		0.30	0.550	132		
0250F	19.00	6.40	0.30	0.330	100	0460U	63.50	12.70		0.30	2.187	152		
19014	19.00	9.50	0.30	0.489	100	04068	63.50	15.90		0.30	2.738	158		
22813	> 20mm	20.00	1.60	0.30	0.087	100	19733	63.50	25.50	0.30	4.391	177		
11404		20.00	2.00	0.30	0.108	100	28267	64.00	12.00	0.30	2.073	151		
70340		20.00	6.00	0.30	0.325	100								
31930		22.00	2.00	0.30	0.119	100	32819	> 70mm	70.00	8.00	0.30	1.518	156	
0034J		22.20	3.20	0.30	0.192	100	26375		75.00	1.30	0.30	0.264	153	
28560		23.00	1.70	0.30	0.105	100	22261		75.00	1.50	0.30	0.305	153	
70256		24.00	2.80	0.30	0.182	100	52087		75.00	1.90	FULL	0.384	152	
28934		25.00	1.50	0.30	0.102	100	70360		76.00	1.50	0.30	0.309	154	
31989		25.00	2.00	0.30	0.135	100	11840		76.00	1.50	FULL	0.307	154	
18223		25.00	2.50	0.30	0.169	100	28461		76.00	13.00	0.30	2.679	177	
10108		25.00	3.00	0.30	0.203	100	18642		76.20	1.90	0.30	0.392	156	
33100		25.00	6.00	0.30	0.406	100	18309		76.20	3.20	0.30	0.661	158	
28340		25.00	9.50	0.30	0.644	100	10170		76.20	6.40	0.30	1.323	165	
10242		25.00	12.00	0.30	0.813	100	0250J	76.20	9.50	0.30	1.963	171		
52085		25.50	3.20	0.30	0.220	100								
35568	25.50	3.80	0.30	0.263	100	20746	> 80mm	80.00	1.60	0.30	0.347	163		
0034A	25.50	4.80	0.30	0.332	100	30682		80.00	5.00	0.30	1.084	169		
10390	25.50	6.40	0.30	0.442	100	24981		80.00	8.00	0.30	1.728	176		
31406	25.50	9.50	0.30	0.657	100	21119		80.00	10.00	0.30	2.164	179		
10901	25.50	12.70	0.30	0.878	100	11176		80.00	45.00	0.30	9.743	245		
21091	29.80	5.50	0.30	0.477	100	18314	89.00	9.50	0.30	2.293	196			
29117	> 30mm	30.00	2.00	0.30	0.163	100	70362	90mm	95.00	15.00	0.30	3.865	219	
21887		30.00	3.00	0.30	0.243	100	25029		97.00	2.00	0.30	0.524	198	
29476		30.00	5.00	0.30	0.406	100								
33962		30.00	10.00	0.30	0.813	100	27939	100mm - 180mm	100.00	3.00	0.30	0.809	206	
11731		31.80	3.20	0.30	0.275	100	70962		100.00	6.00	0.30	1.627	212	
18370		31.80	6.40	0.30	0.551	100	34260		100.00	8.00	0.30	2.168	214	
20260		31.80	4.80	0.30	0.414	100	33987		100.00	8.00	1.00	2.169	216	
31419		31.80	9.50	0.30	0.819	100	34262		100.00	10.00	1.30	2.708	218	
21126		34.00	8.00	0.30	0.737	100	33017		100.00	12.00	0.30	3.255	223	
33049		35.00	3.20	0.30	0.304	100	37599		100.00	12.50	0.30	3.389	224	
70352		38.00	1.50	0.30	0.154	100	28402		100.00	15.00	0.30	4.070	229	
31920		38.00	2.00	0.30	0.205	100	32800		100.00	16.00	0.30	4.339	232	
11733		38.00	3.20	0.30	0.330	100	11781		101.00	9.50	1.00	2.599	221	
0460K		38.00	4.80	0.30	0.494	100	23812		101.50	2.00	0.50	0.551	207	
72223		38.00	6.00	0.30	0.618	100	21118		120.00	15.00	1.60	4.876	268	
0034C	38.00	6.40	0.30	0.659	100	19554	127.00		9.50	0.50	3.271	272		
0250U	38.00	12.70	0.30	1.309	101	36635	150.00	12.20	0.30	4.963	324			
0034S	38.10	9.50	0.30	0.979	100	36071	150.00	15.00	1.00	6.100	215			
25025	> 40mm	40.00	2.50	0.30	0.271	100	10985	160.00	10.00	3.00	4.318	335		
34355		40.00	5.00	0.30	0.542	100	21449	180.00	6.00	0.30	2.929	372		
19724		40.00	8.00	0.30	0.868	100								
20098		40.00	20.00	0.30	2.169	119								
36450		44.50	16.50	0.30	1.991	121								
11609		46.00	1.20	0.30	0.149	100								

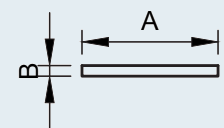

TUBING
 Square 2
 Rectangular 3
 Round 4-5

ANGLES
 Equal Leg 6
 Unequal Leg 7

CHANNELS
 Equal Leg 8-9
 Lipped & Top Hat 10

MISC
 T & H Sections 11

BARS
 Flat Bar 12
 Hexagon Bar 13
 Square Bar 13
 Round Bar 13

Material Specifications

All material will be Aluminium 6063-T6 unless specified or requested. All lengths can be supplied in 6m lengths. Longer lengths can be supplied on special request.

Surface Finish

All lengths are available in mill finish, powder coated or anodized.

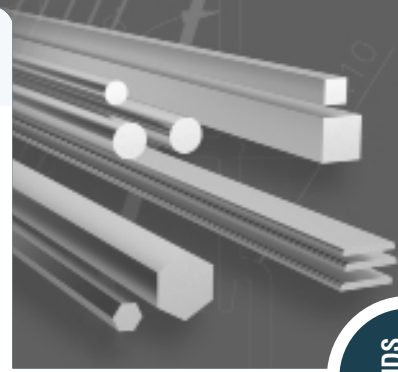

SOLIDS

ROUND BAR

SECTION NO.	RANGE	A	Kg/m	PAINT / ANODIZED PERIMETER
70192	< 10mm	4.80	0.049	100
20041		6.00	0.077	100
11921		6.35	0.085	100
33029		7.00	0.104	100
71156		8.00	0.136	100
52474		9.50	0.192	100
52068		> 10mm	10.00	0.213
52326	12.00		0.306	100
22044	12.70		0.343	100
31413	14.00		0.417	100
22233	15.00		0.479	100
52331	16.00		0.545	100
11854	18.00		0.690	100
11873	19.00	0.769	100	
52327	> 20mm	20.00	0.852	100
28459		22.00	1.031	100
52098		23.00	1.126	100
52328		25.00	1.331	100
28539		28.00	1.670	100
33609	> 30mm	30.00	1.917	100
52369		31.80	2.154	100
28066		32.00	2.171	101
52036		32.60	2.263	103
31421		33.30	2.362	104
52370		35.00	2.610	110
11651		38.00	3.076	120
28125	> 40mm	40.00	3.392	126
30634		42.00	3.757	132
52742		45.00	4.313	141
31416		49.00	5.114	153
22497	> 50mm	50.00	5.327	157
34072		60.00	7.750	190
32418		66.00	9.279	207
31417		75.00	11.982	235

SQUARE BAR

SECTION NO.	RANGE	A	Kg/m	PAINT / ANODIZED PERIMETER
22050		9.50	0.245	100
70519	10mm	12.00	0.390	100
22051		12.70	0.437	100
22248		16.00	0.694	100
31407		17.00	0.783	100
22052		19.00	0.979	100
10092	20mm	25.00	1.694	100
22053		25.50	1.763	101
20049	30mm	31.80	2.743	127
10093		32.00	2.775	128
52373		38.00	3.916	151
34759		50.00	6.781	200

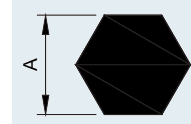
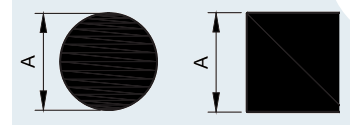

HEXAGON BARS

SECTION NO.	A	Kg/m	PAINT / ANODIZED PERIMETER
71491	6.00	0.084	100
22253	25.70	1.551	100

TUBING

- Square 2
- Rectangular 3
- Round 4-5

ANGLES

- Equal Leg 6
- Unequal Leg 7

CHANNELS

- Equal Leg 8-9
- Lipped & Top Hat 10

MISC

- T & H Sections 11

BARS

- Flat Bar 12
- Hexagon Bar 13
- Square Bar 13
- Round Bar 13

Material Specifications

All material will be Aluminium 6063-T6 unless specified or requested. All lengths can be supplied in 6m lengths. Longer lengths can be supplied on special request.

Surface Finish

All lengths are available in mill finish, powder coated or anodised.